

A Tribute to the 70s Galaxy Explorer

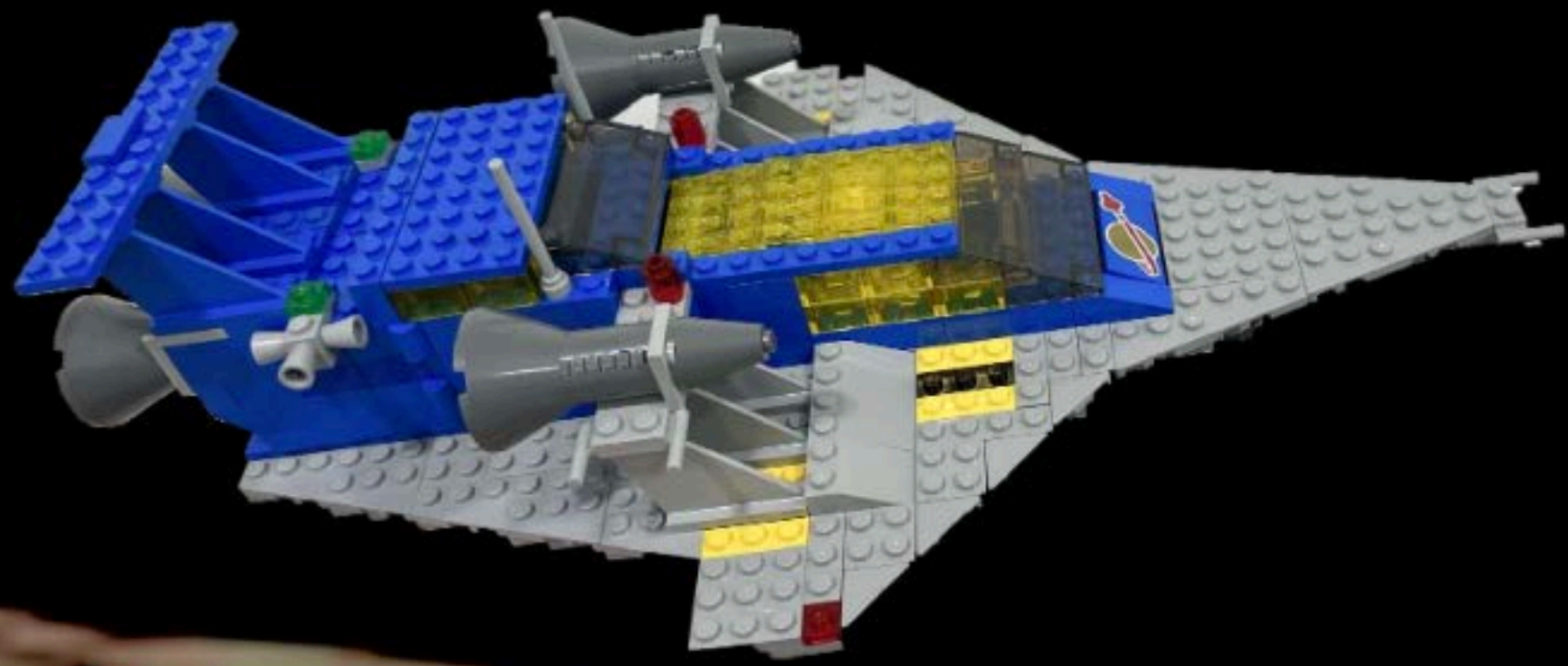

A word from Robin.

When I visited the LEGO House with my children, we saw the original 1979 Galaxy Explorer on display. I told my children that as a child this was my favourite design and how it first stirred my interest into spacecraft, which later resulted in a career in spacecraft design at the European Space Agency.

When we got home, we decided to try and build the Space Galaxy Explorer using the bricks that my children had, and soon I realised that due to the obsolescence of some bricks of the 70's, a re-design was necessary.

I learned to use the Studio software and redesigned the Space Galaxy Explorer based on bricks available today, keeping as much as possible both the original design and original instructions the same.

Some parts, in particular the lid covering the steering compartment, are difficult to mount; I simply did not find a better solution based on modern bricks and transparent yellow. Any proposals for improvement are welcome!

Still, the result is what I call a 'Tirbute to the 70s Galaxy Explorer' as the size and general layout of this design matches very closely that of the original. It concerns only the space plane; the buggy and the little base are not included. Maybe one day I will update the design to include those too.

It has been a great journey with my children to get to this built. I hope these instructions will make you equally as enthusiastic and / or bring back happy memories from the 70's.

Enjoy!

Robin Biesbroek

1

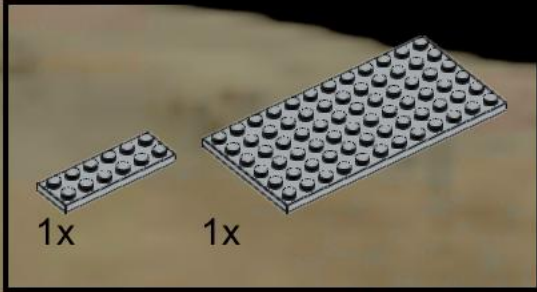

2

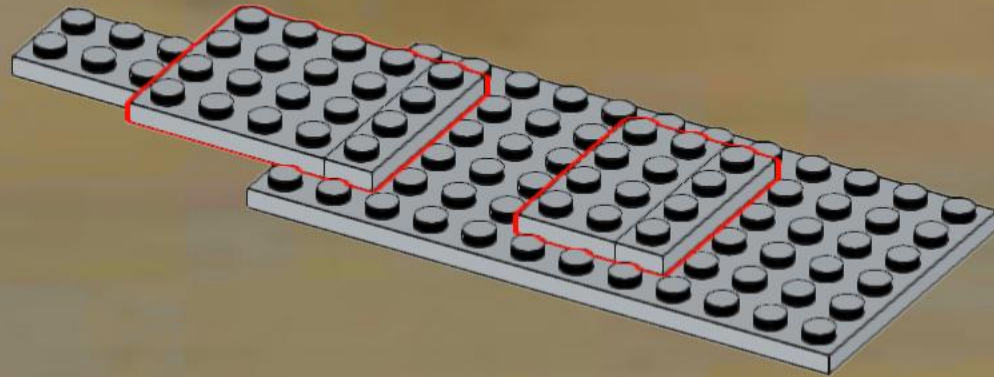

3

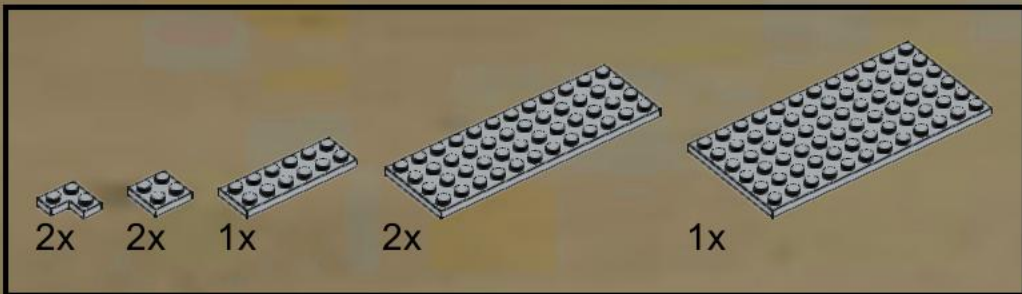

4

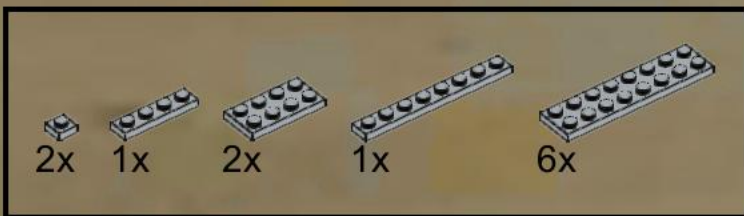
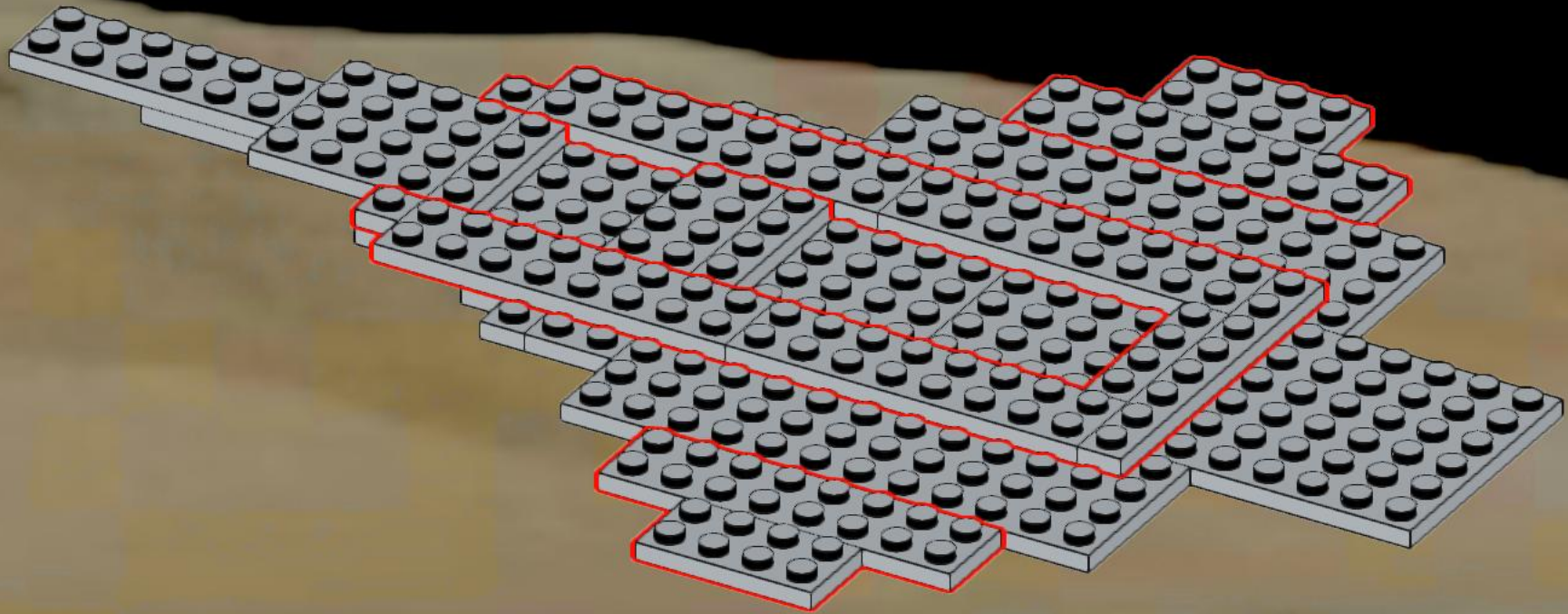

5

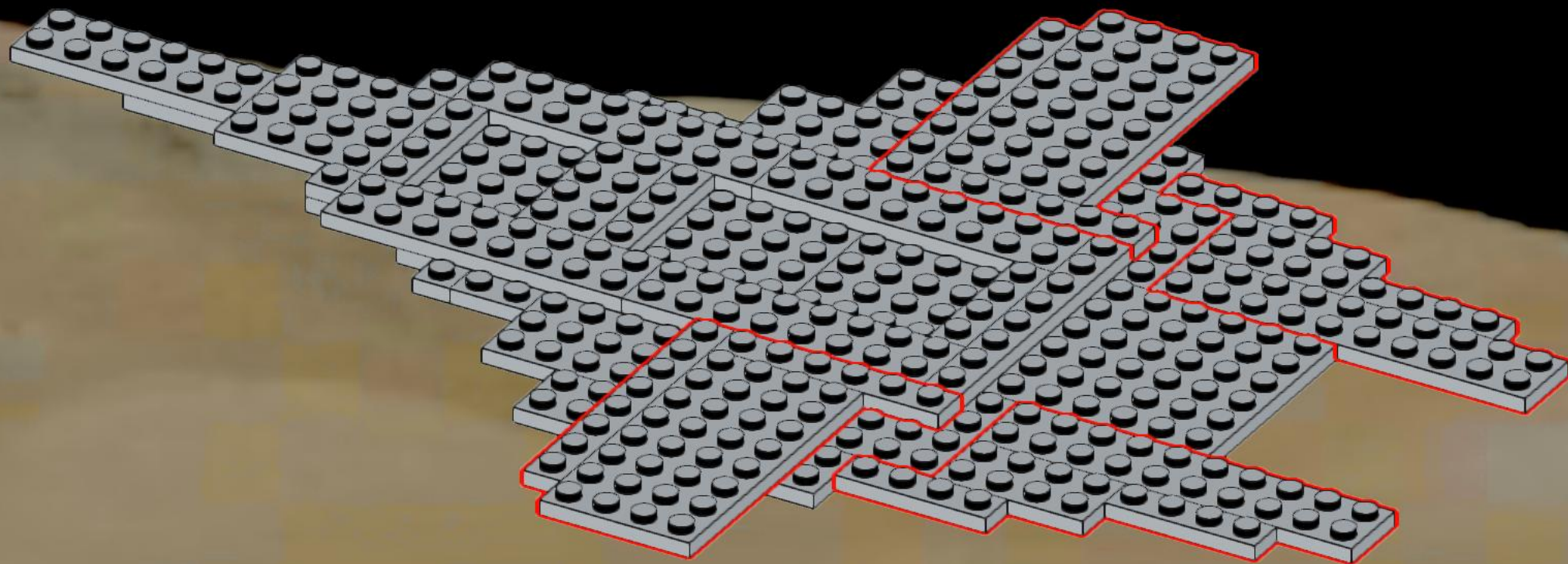

6

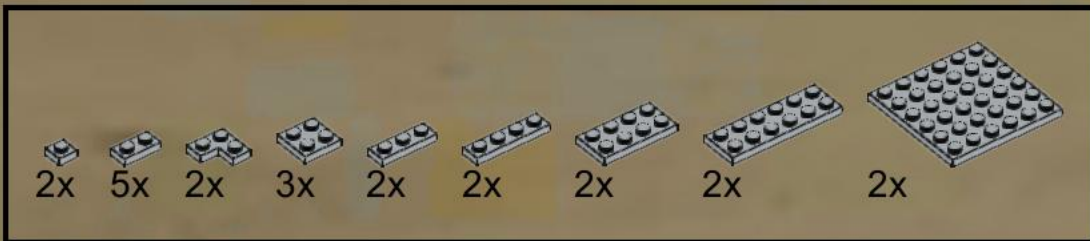
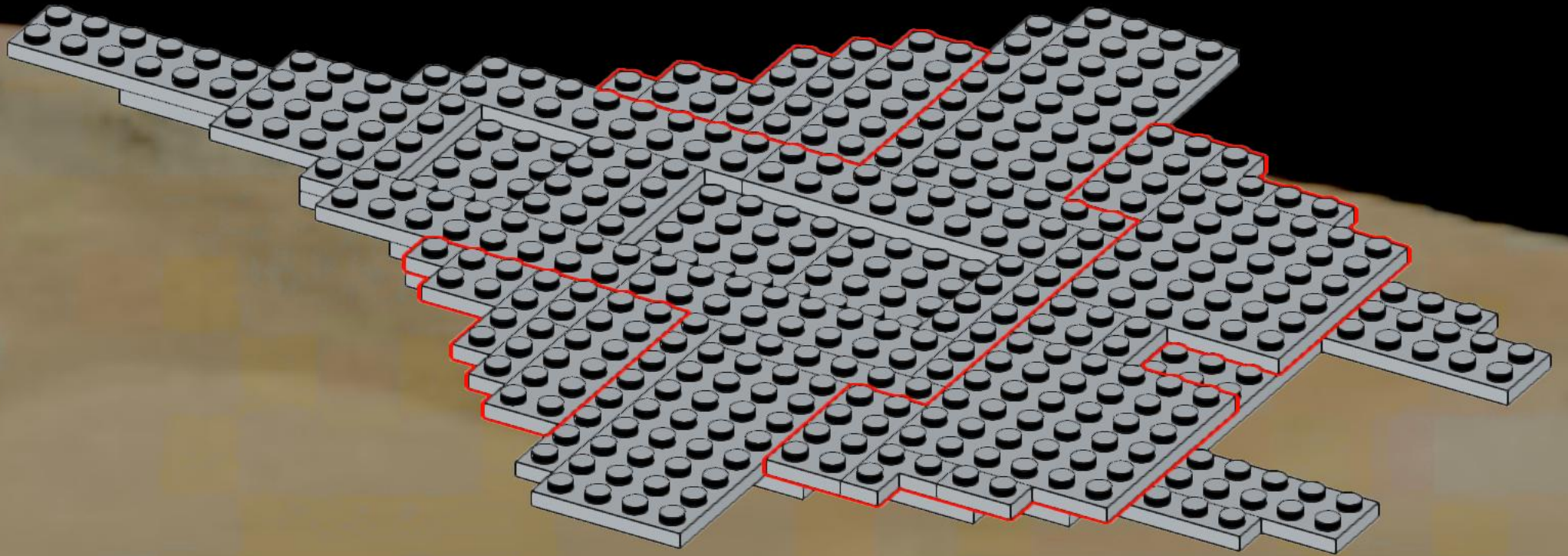

7

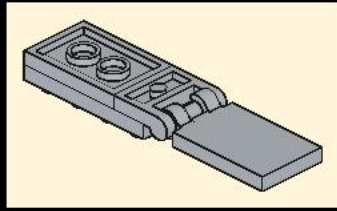

9

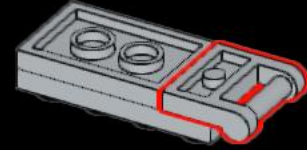
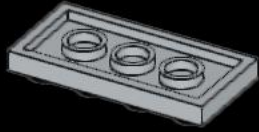

1x

8

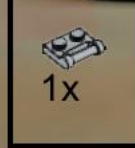

1x

10

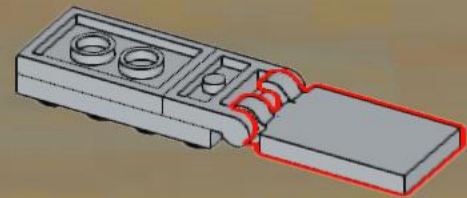
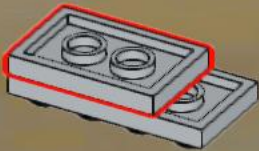

1x



1x

11

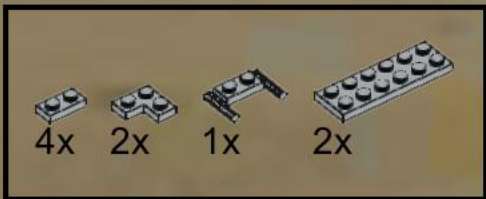
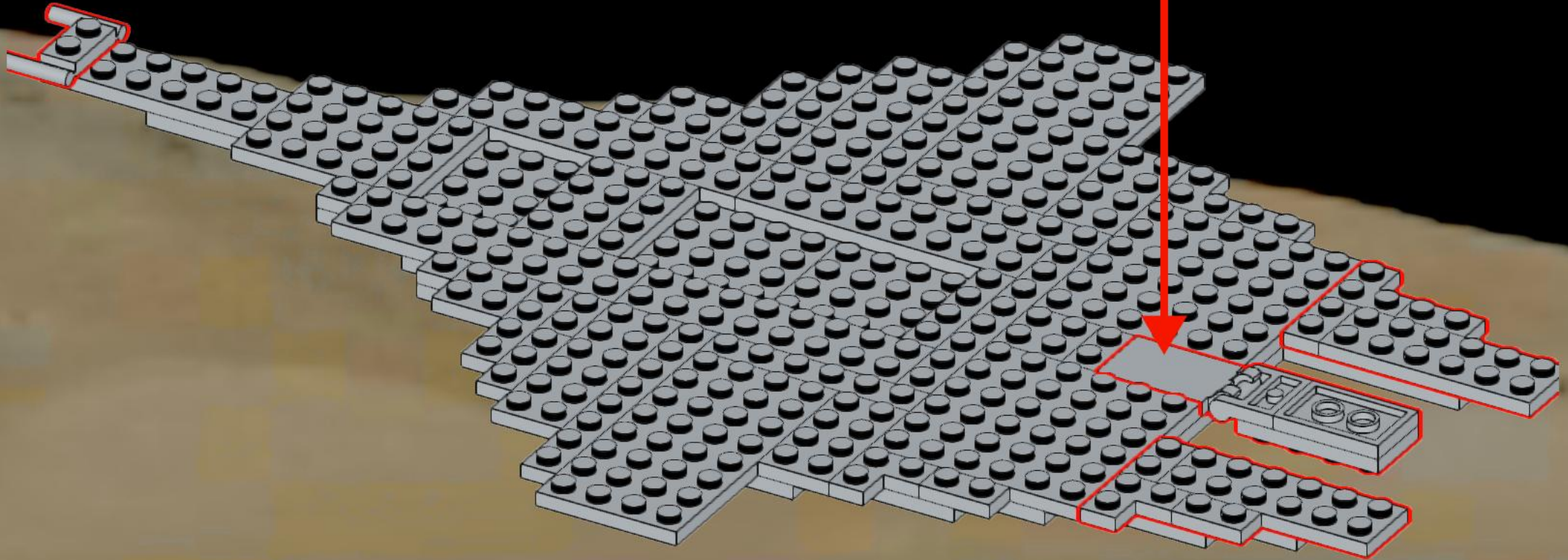

12

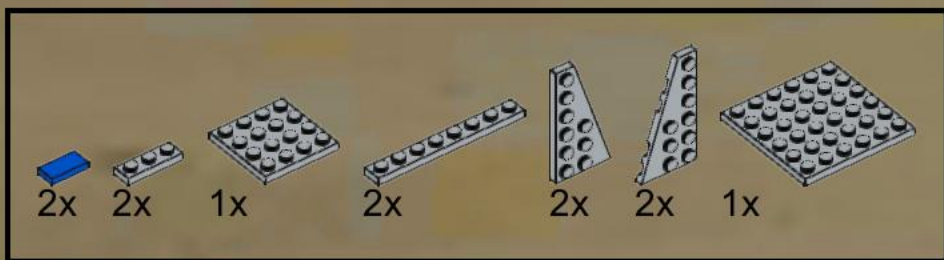
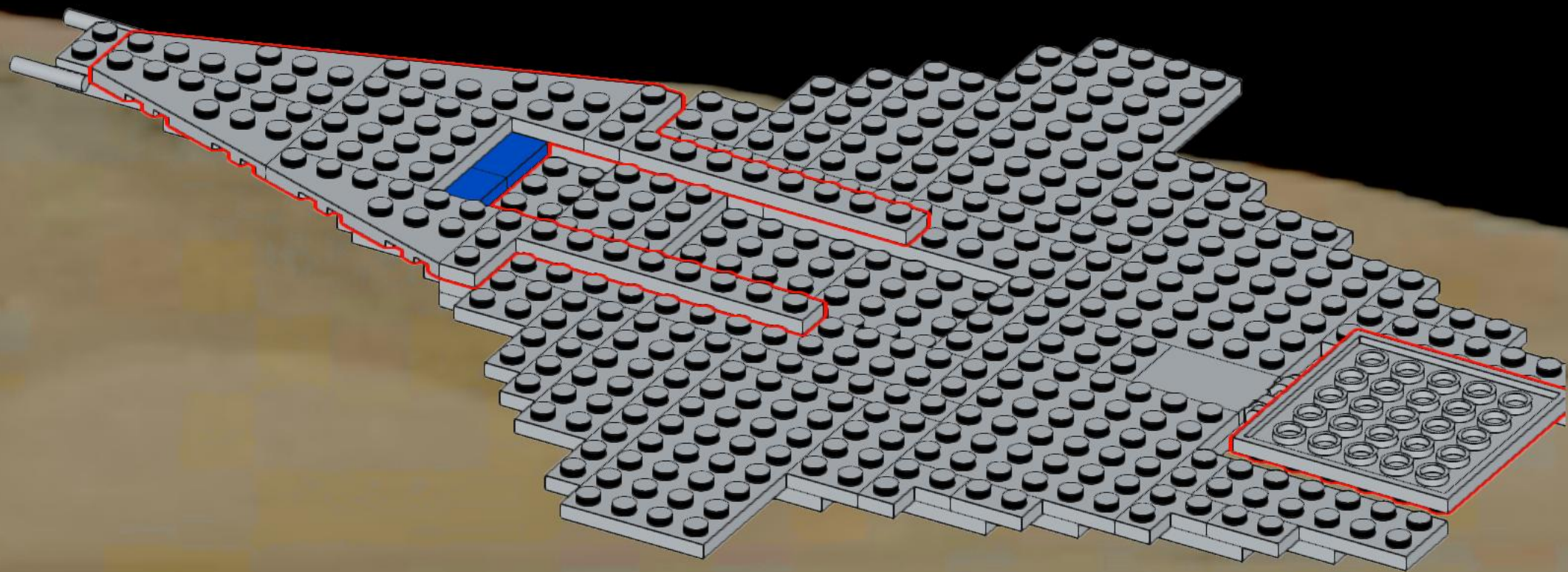

13

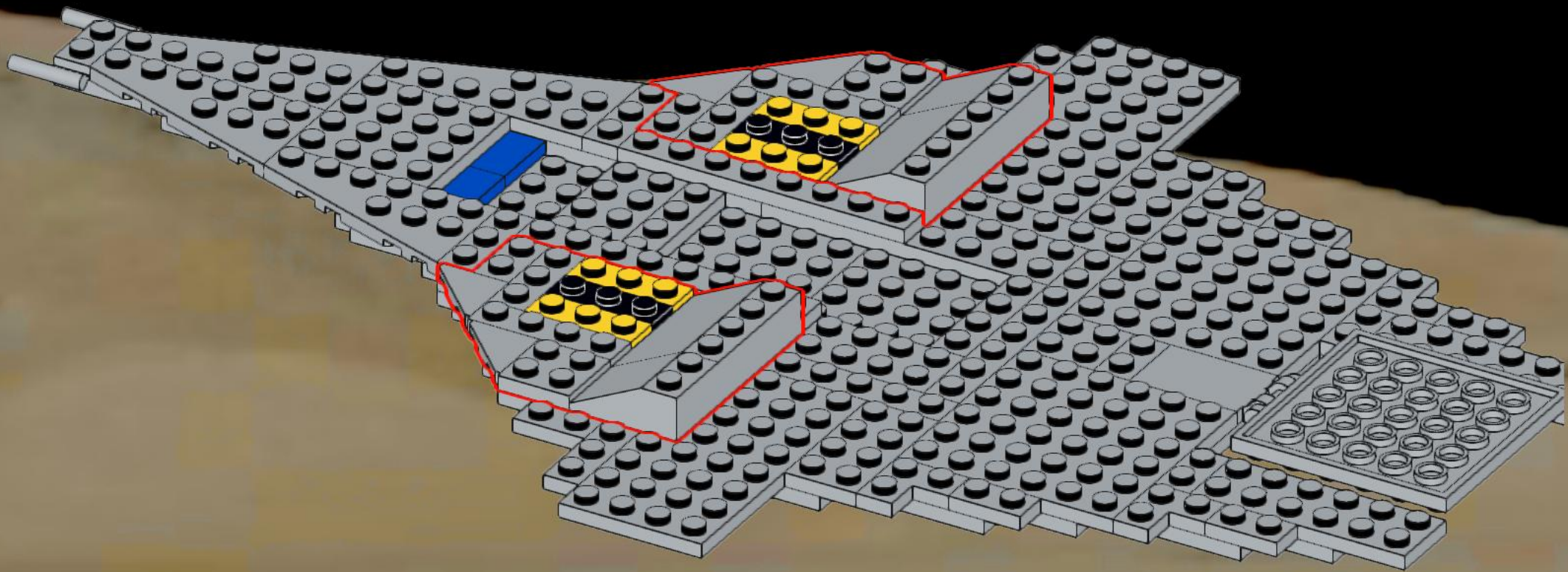

14

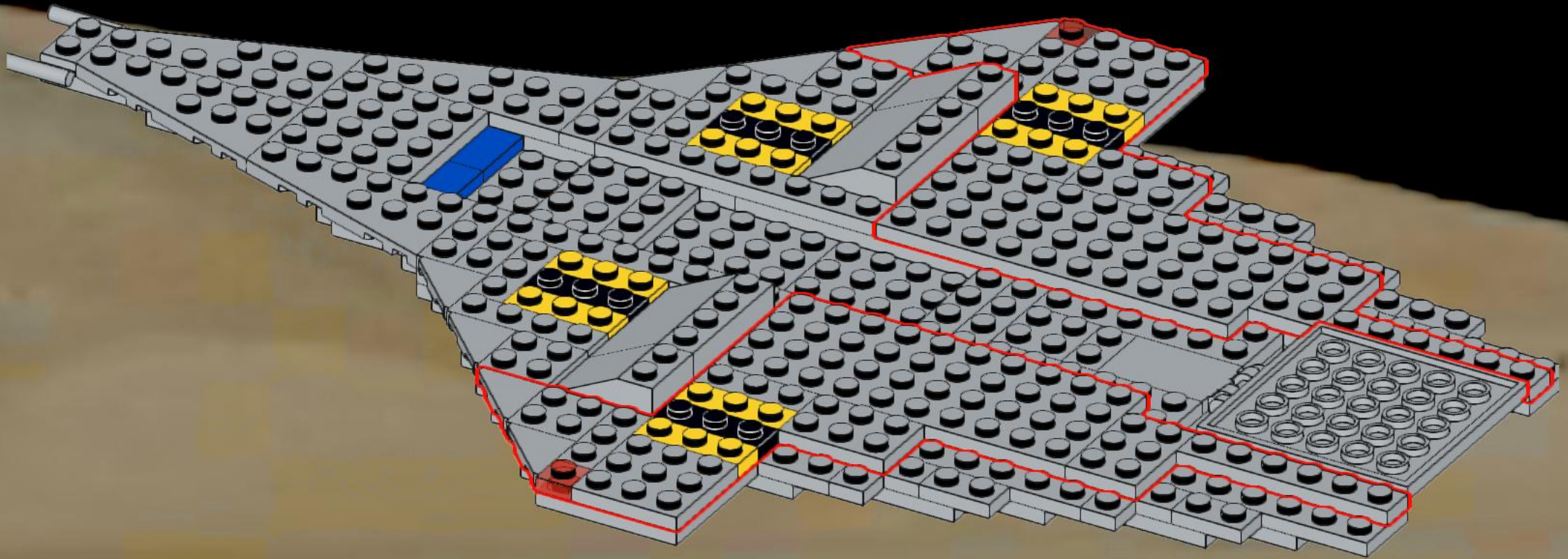

15

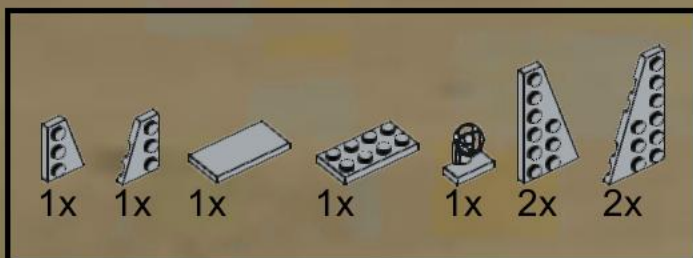
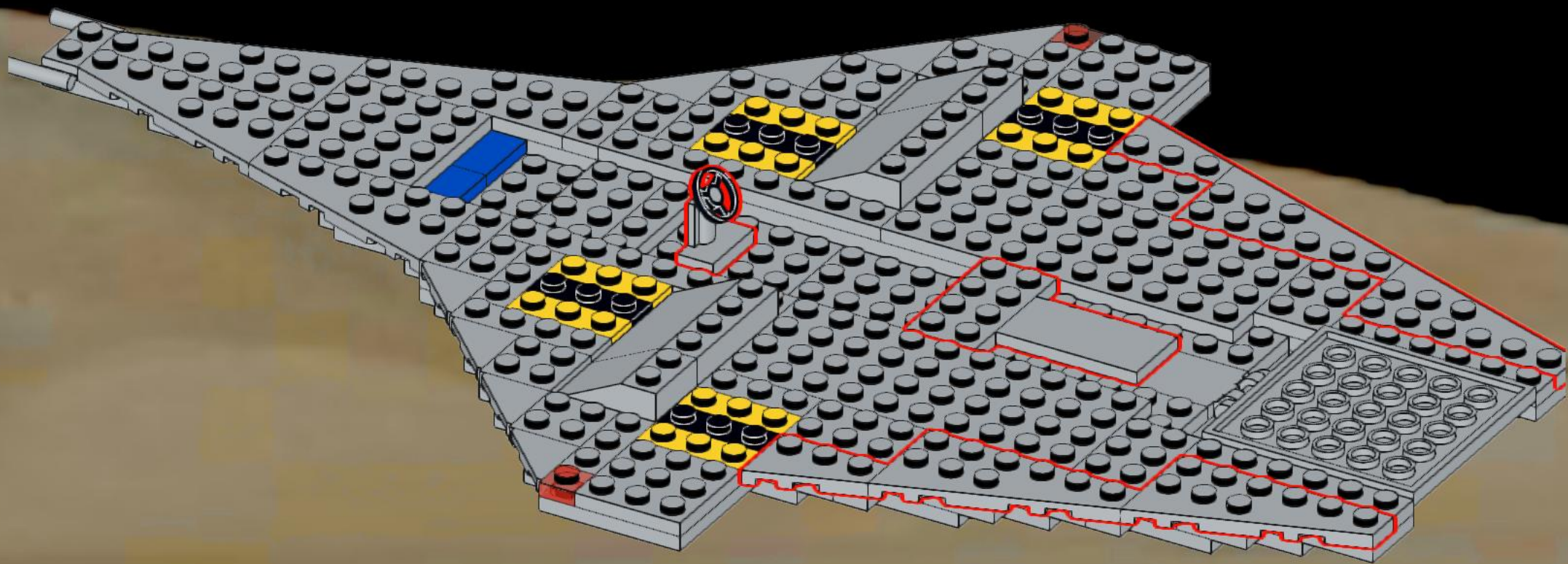

16

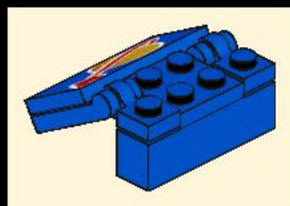
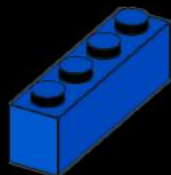

18

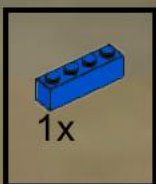
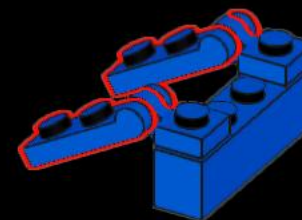

17

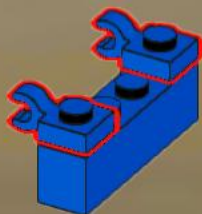

19



20

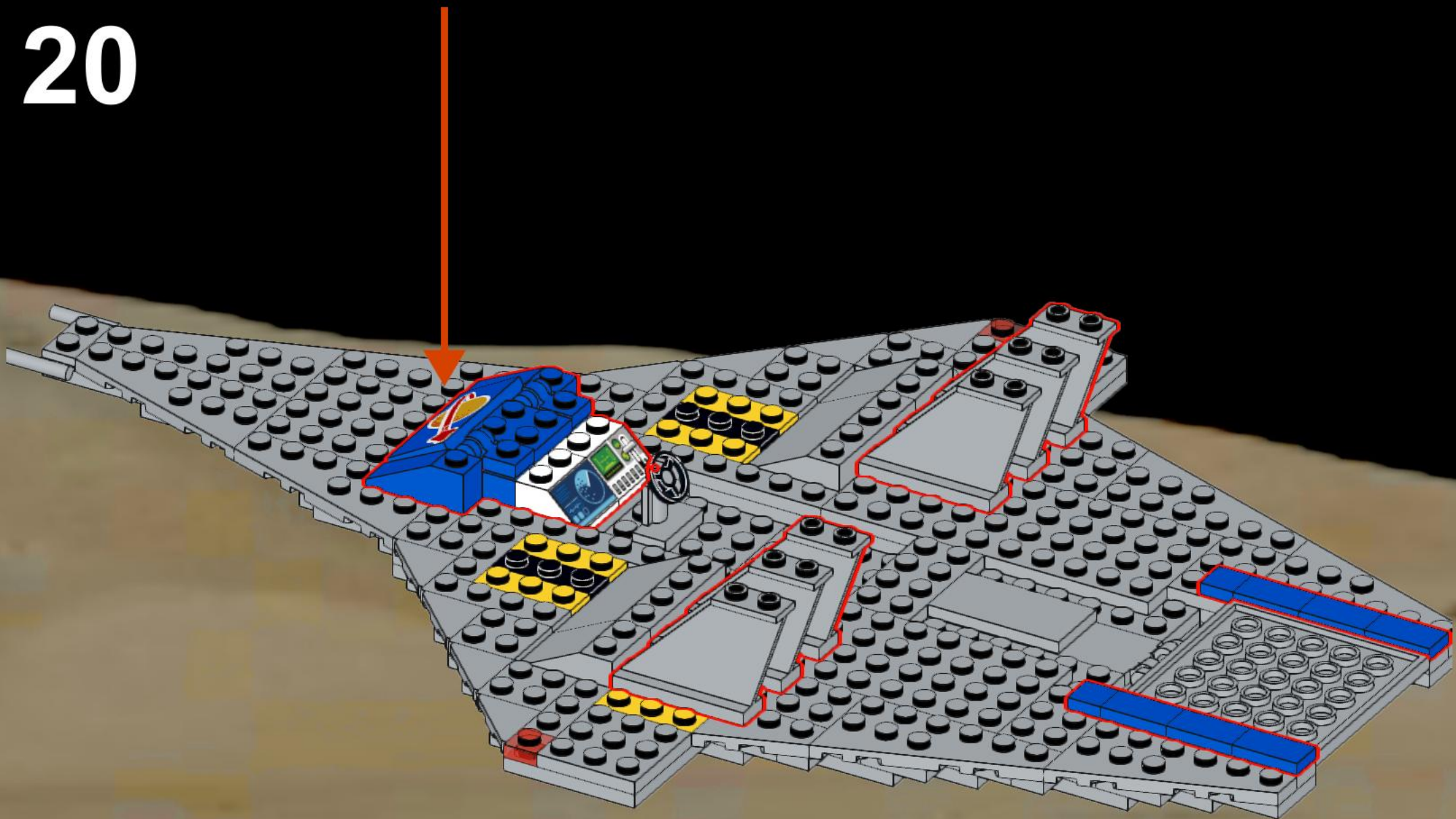

21

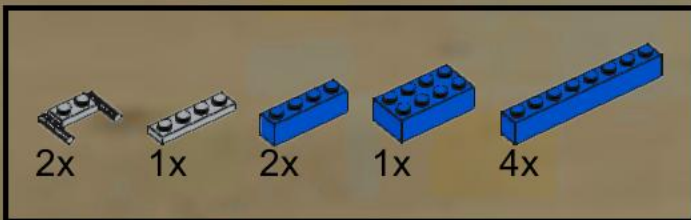
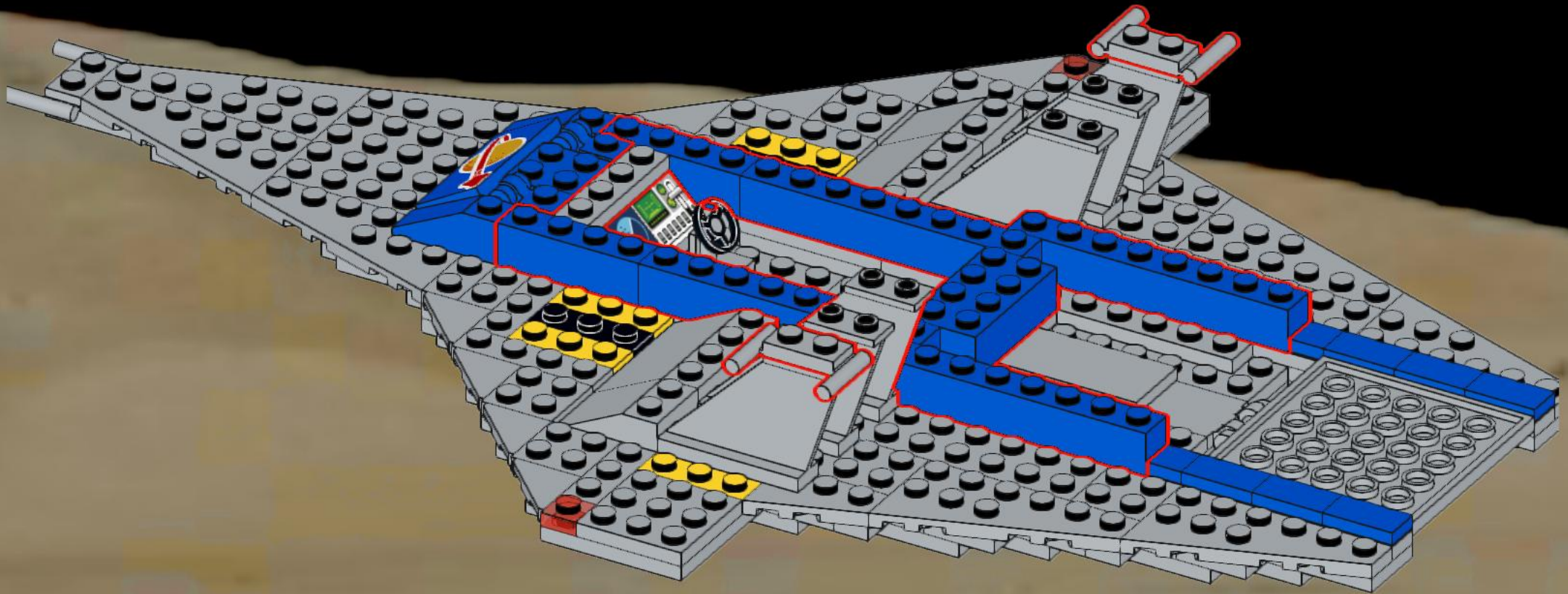

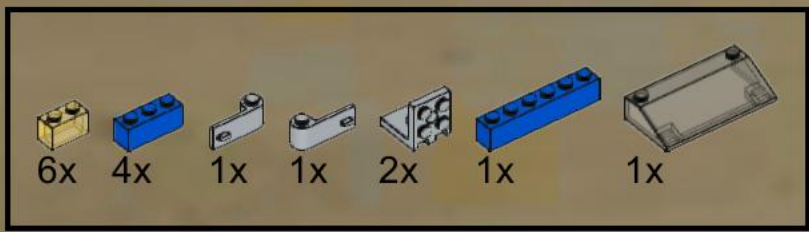
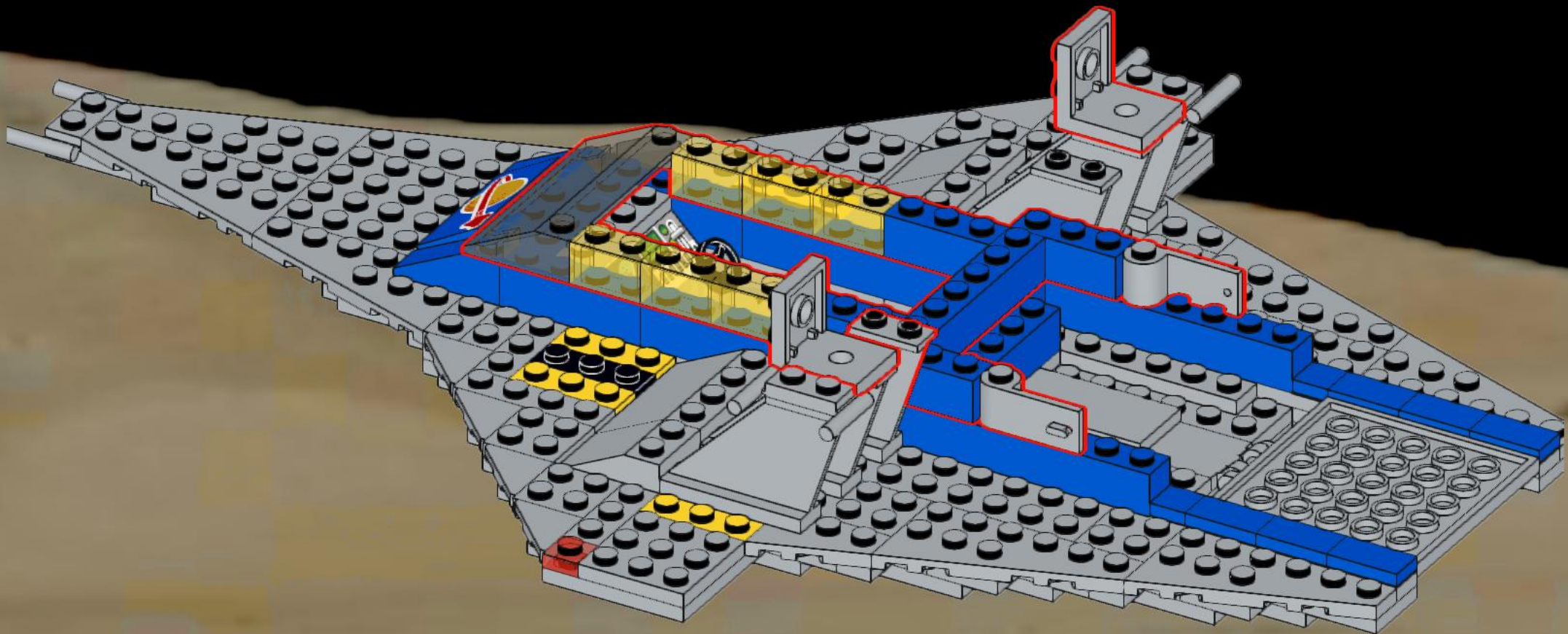

23

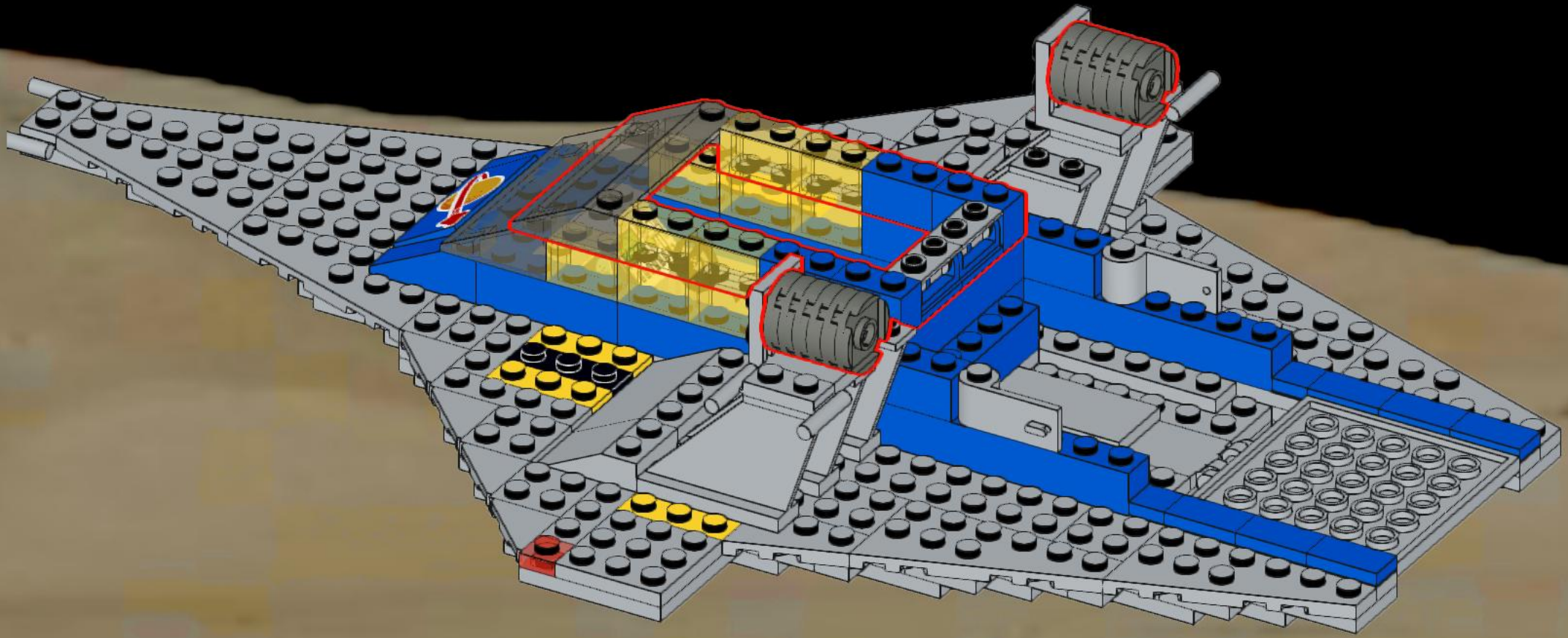

- 2x
- 2x
- 4x
- 4x
- 12x
- 1x

24

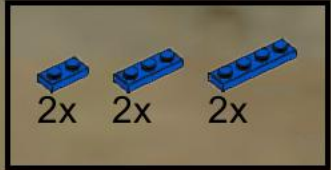
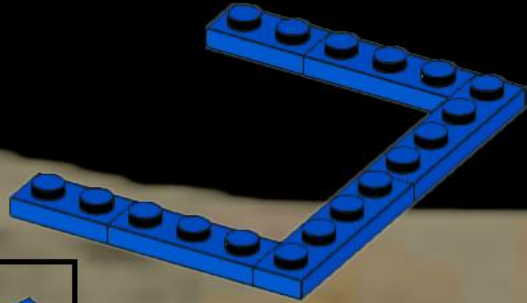
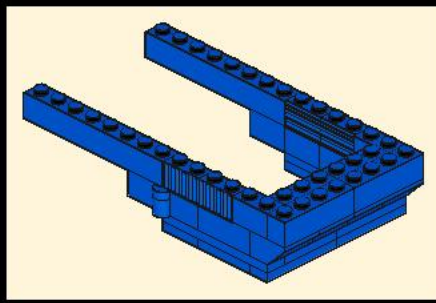

26

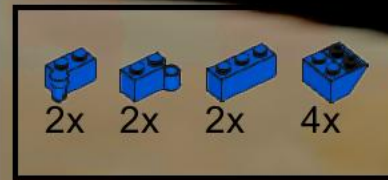
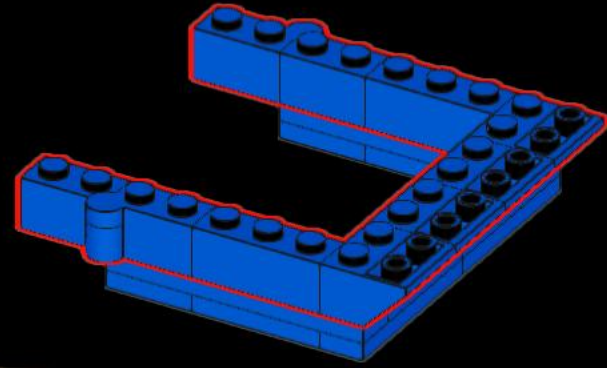

25

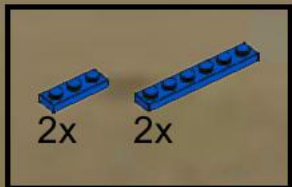
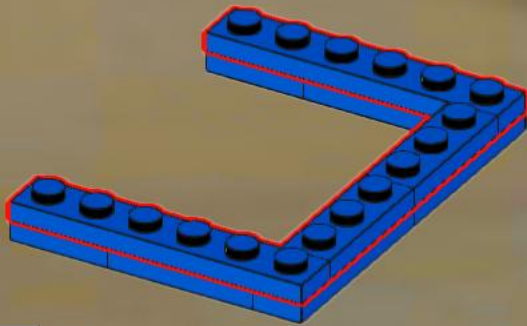

27

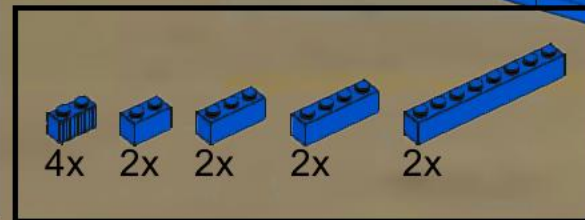
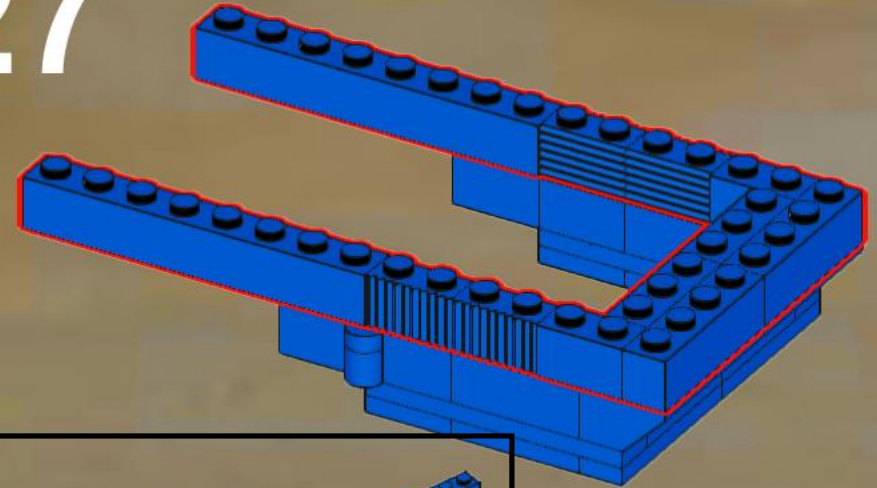

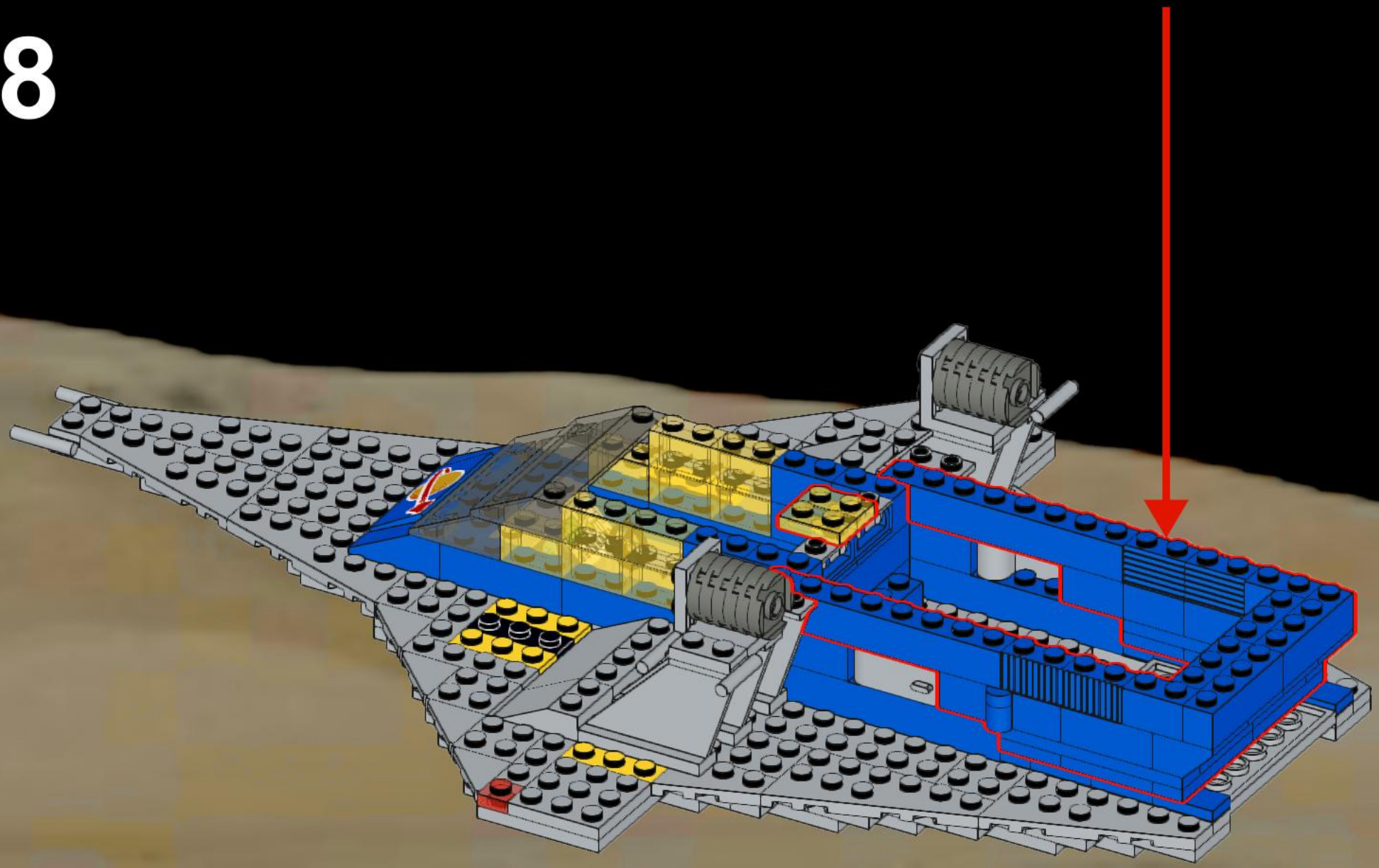

29

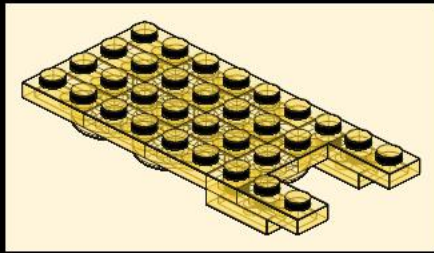

31

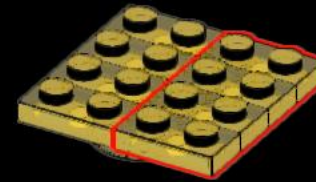

30

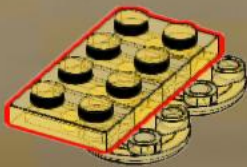

32

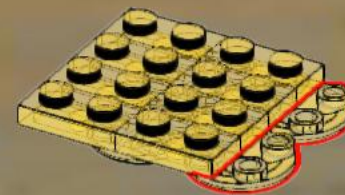

33

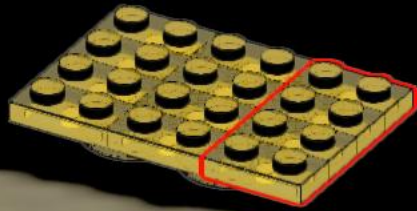

35

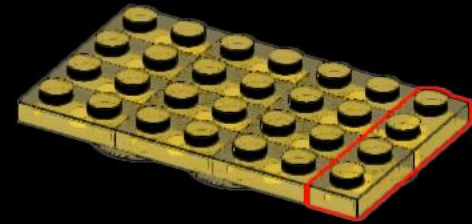

34

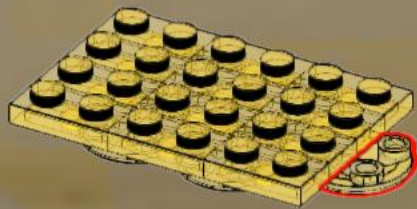

36

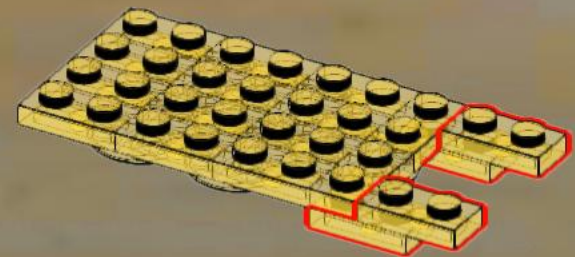

37

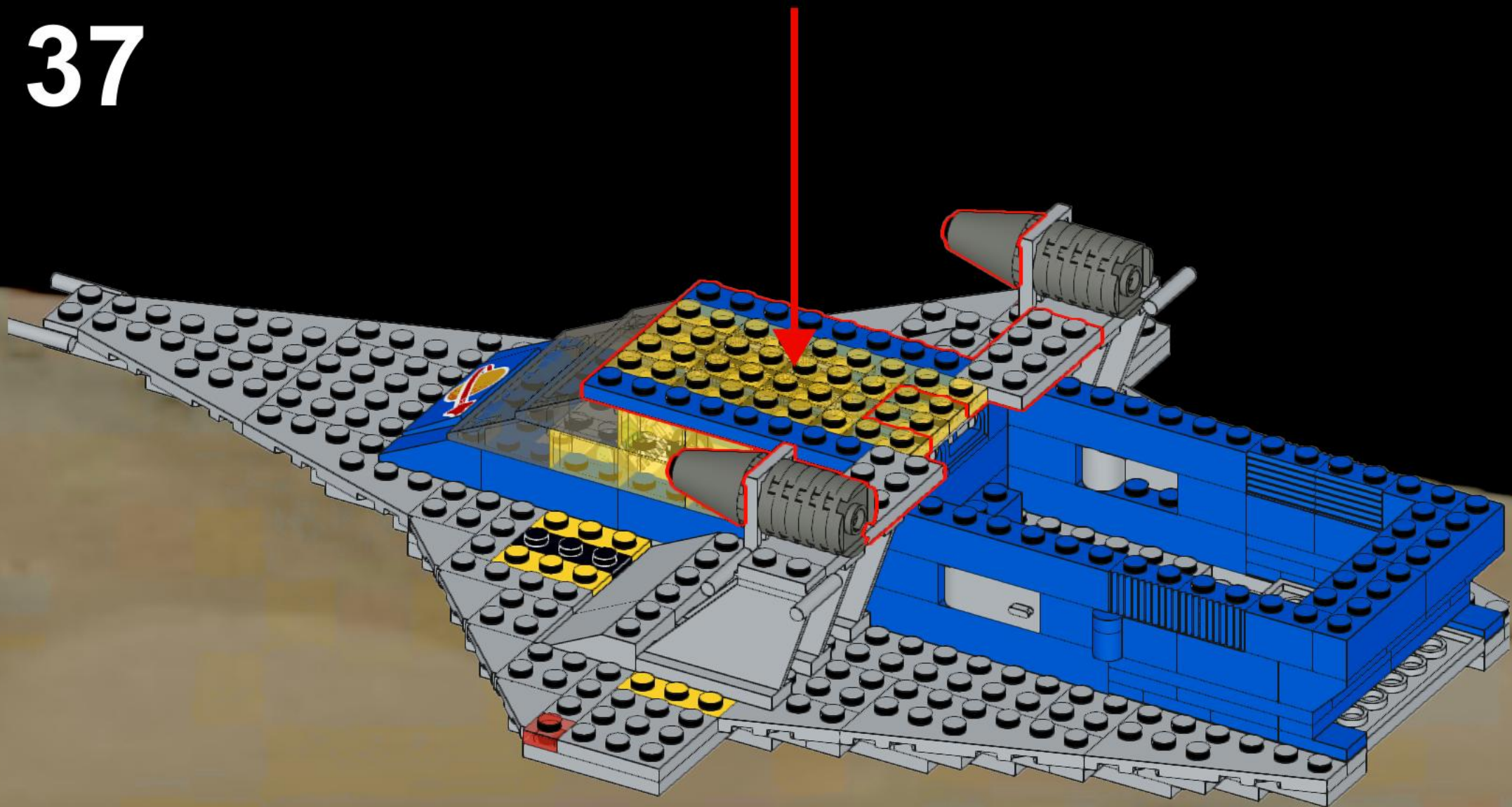

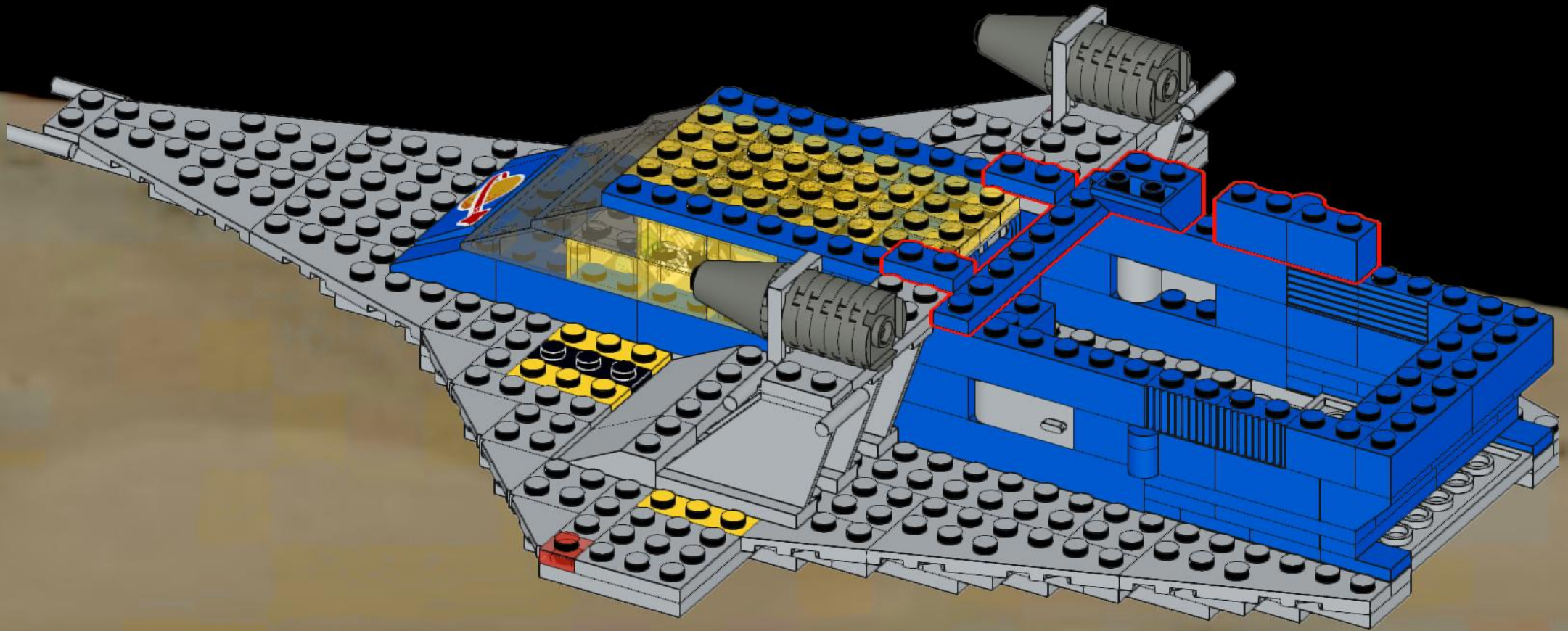

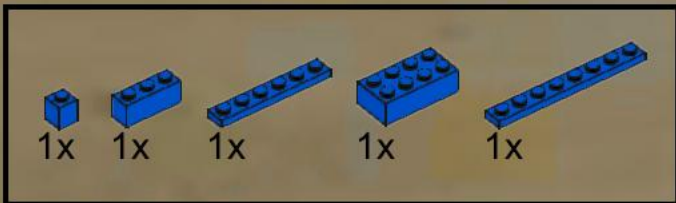
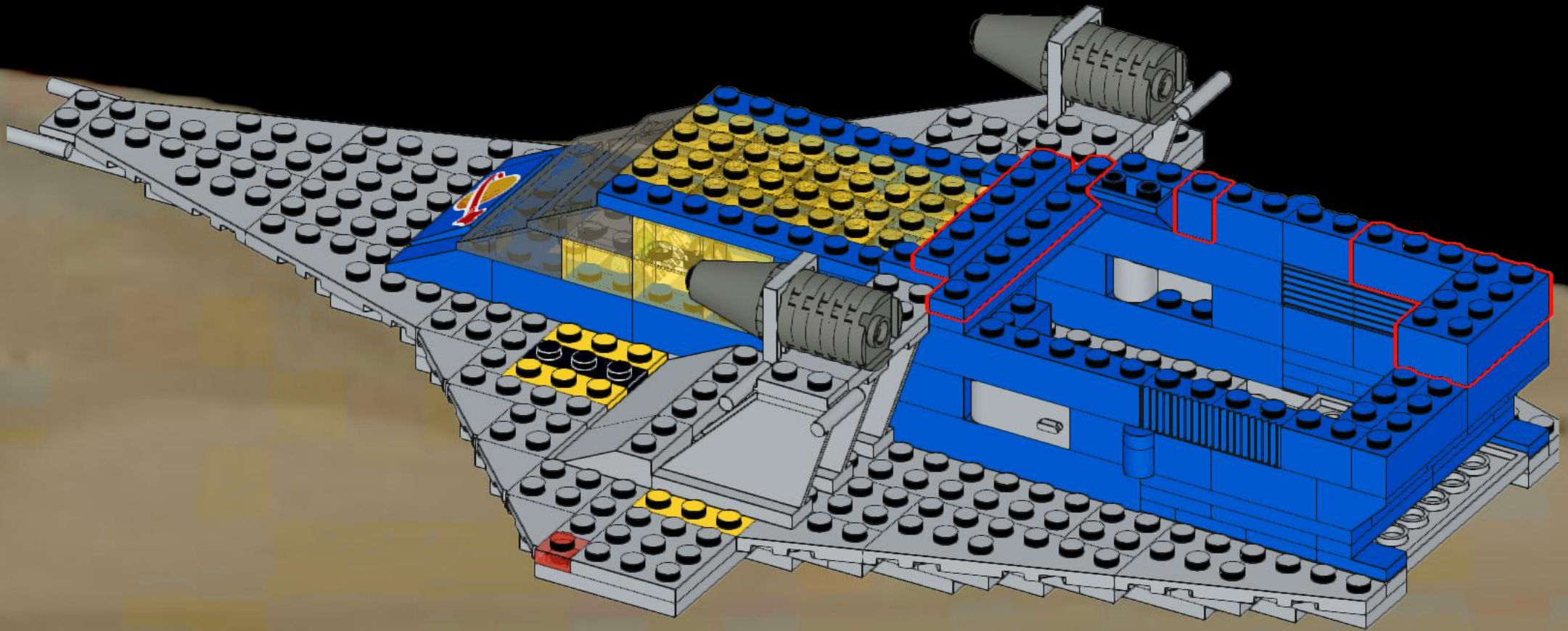

40

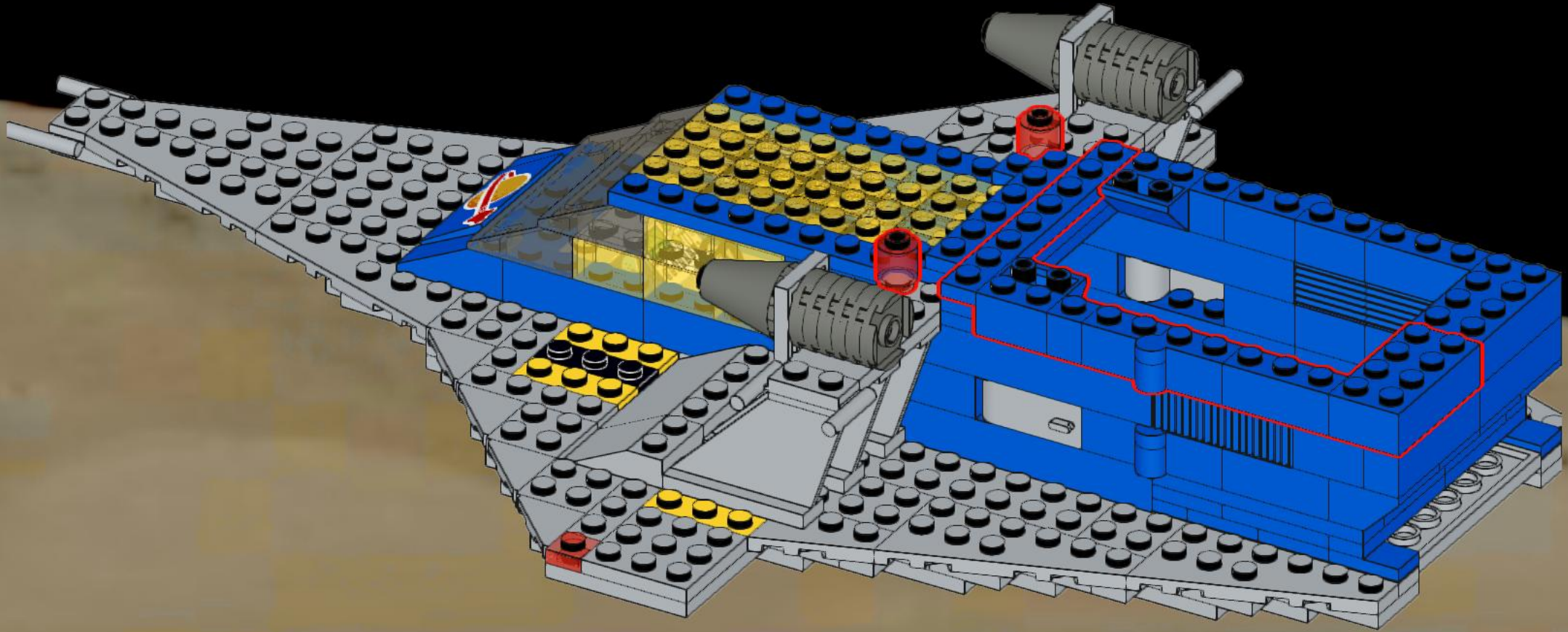

41

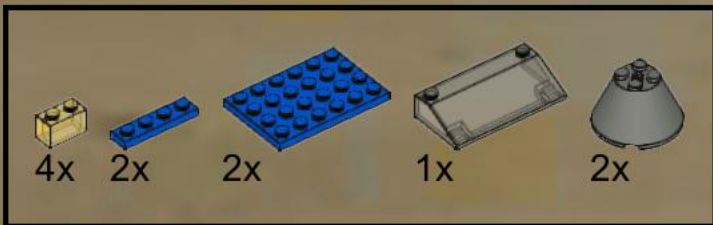
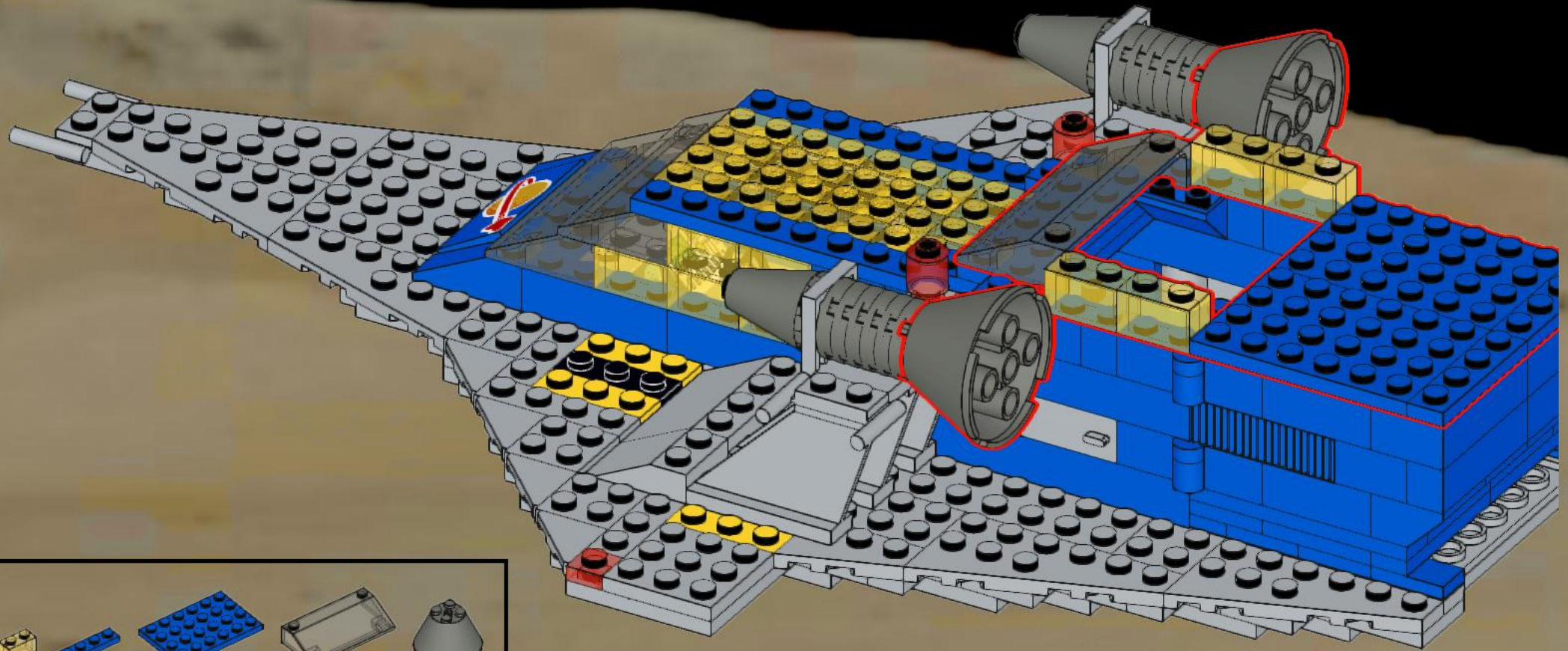

42

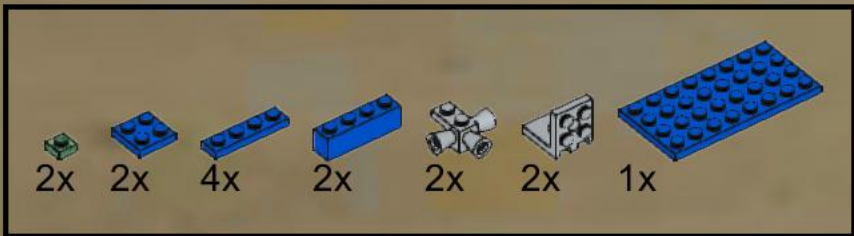
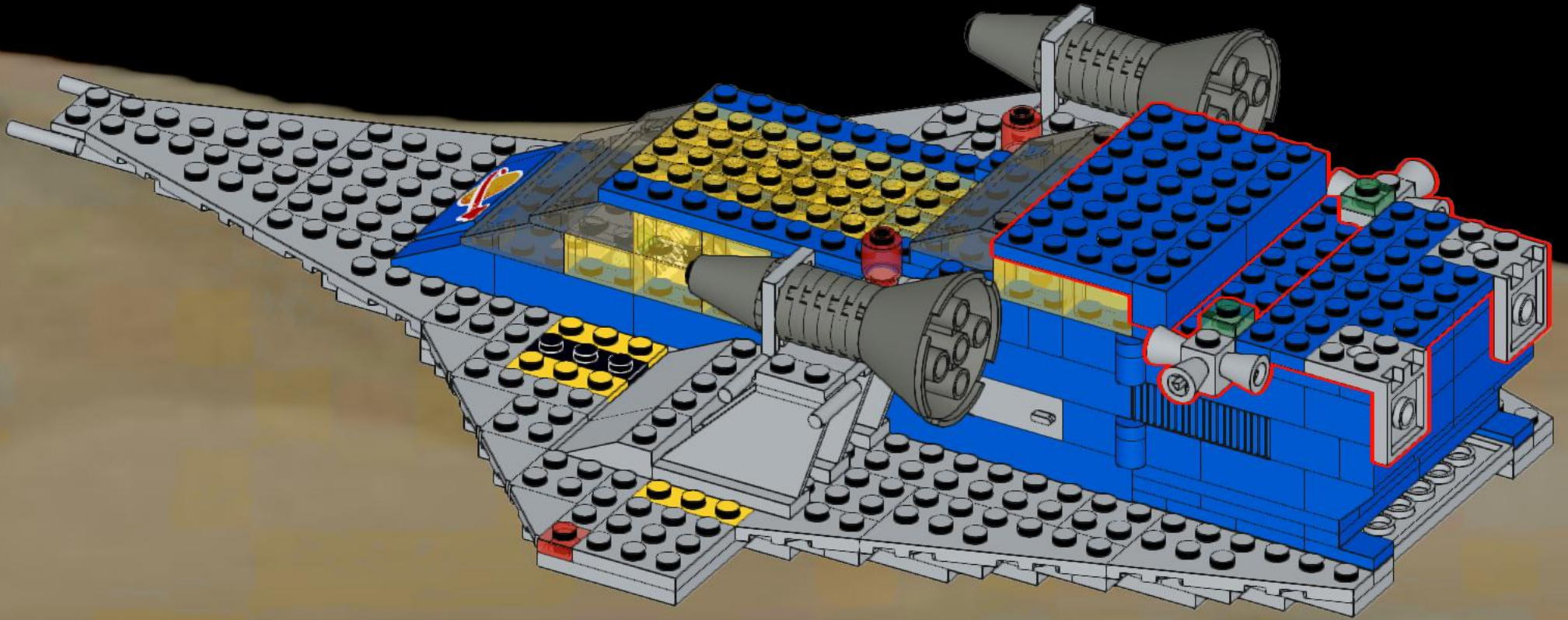

43

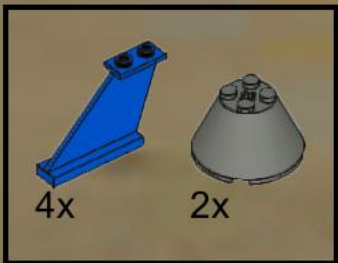
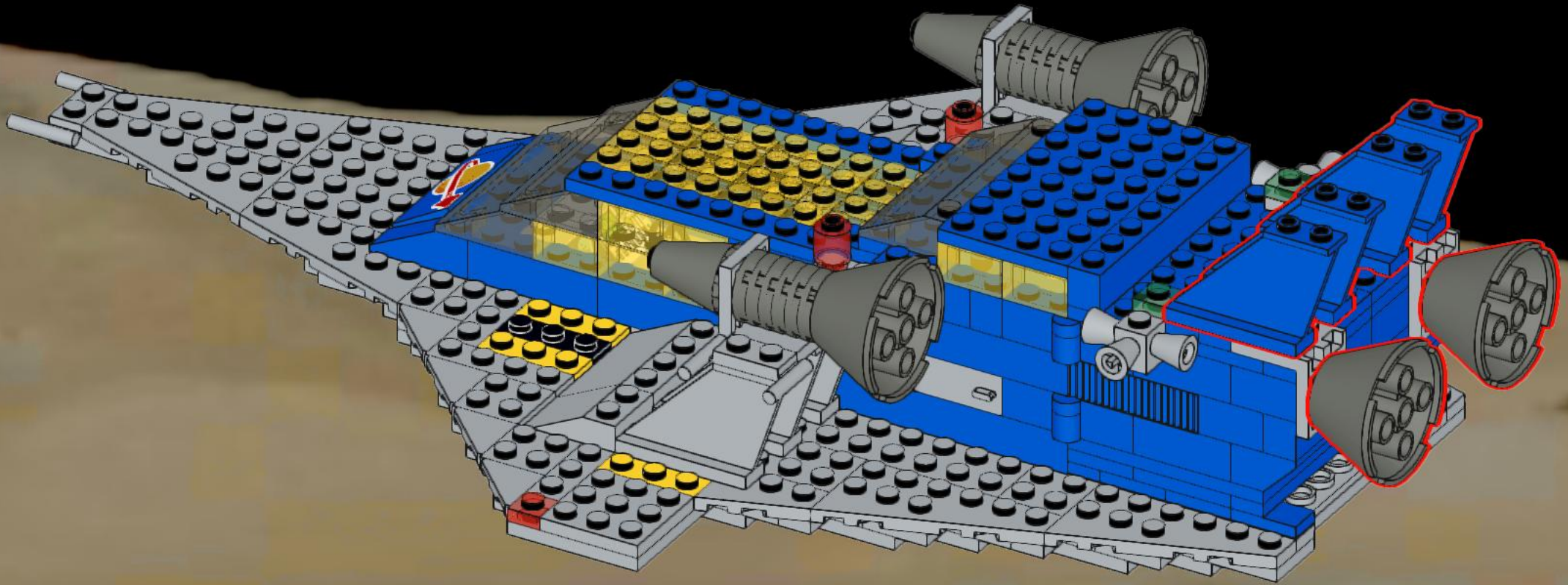

44

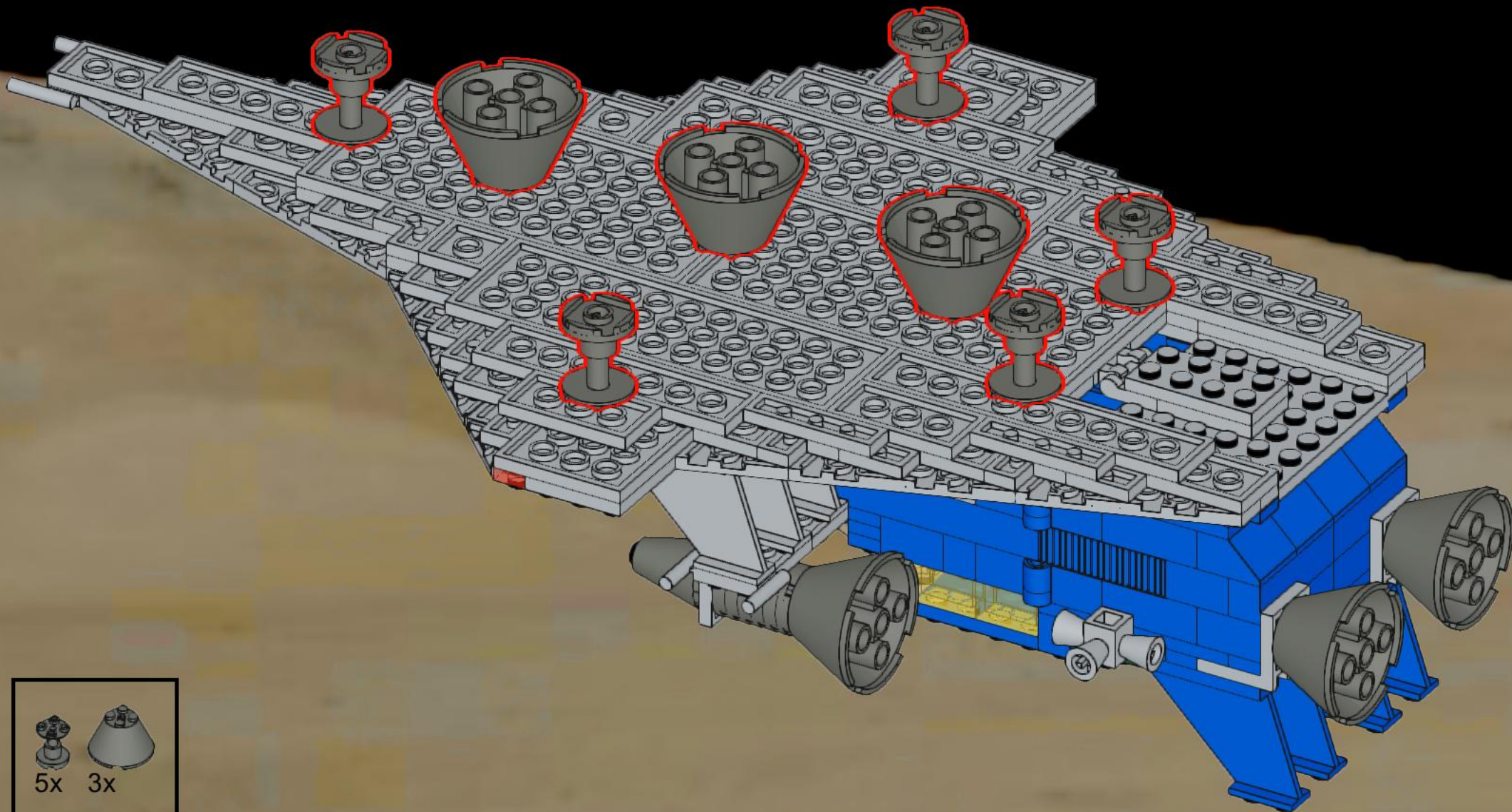

45

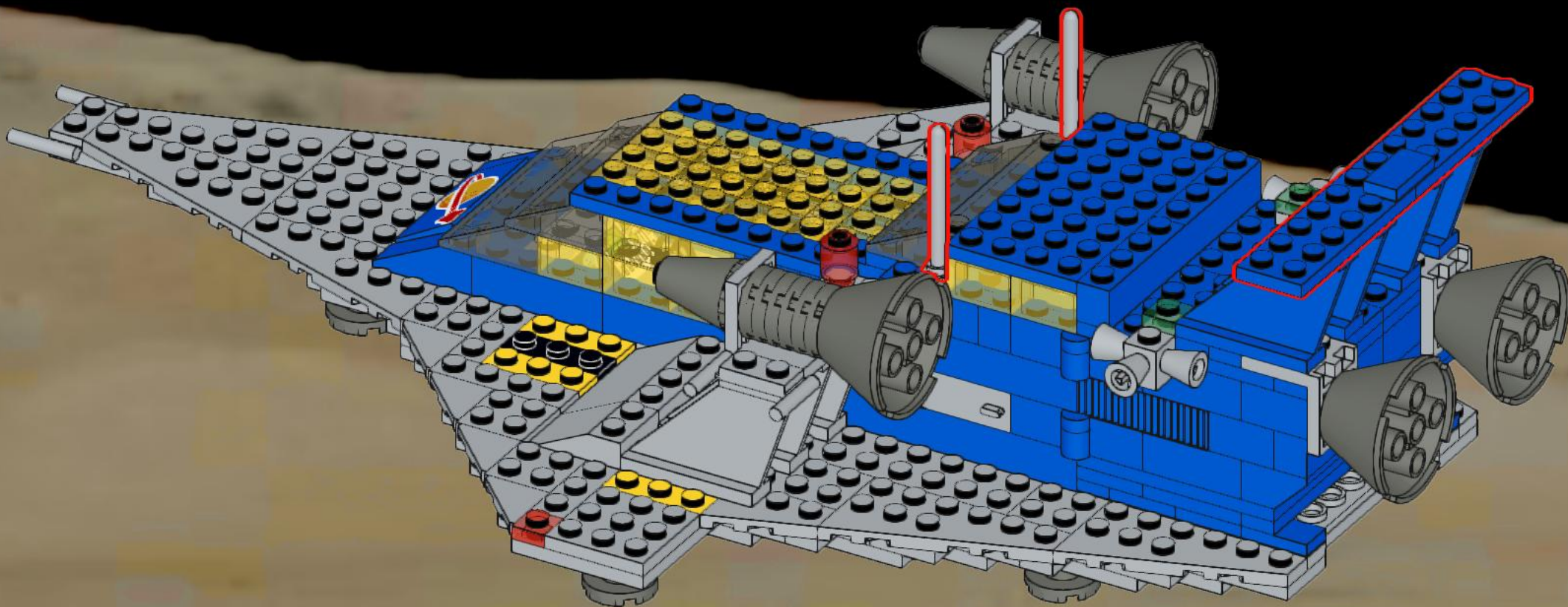

Note: Lego element-ID number is shown in blue



4x
3623 (362326)
Black

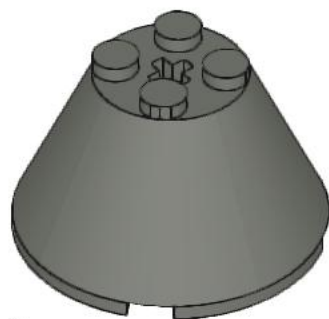

7x
3943b (4296788)
Dark Bluish Gray

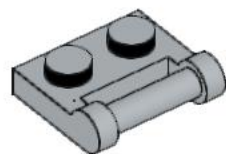

1x
48336 (4244627)
Light Bluish Gray

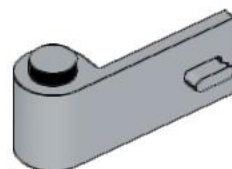

1x
3822 (6078212)
Light Bluish Gray

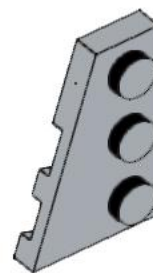

1x
43723 (4211794)
Light Bluish Gray

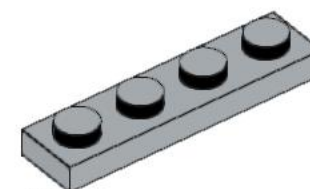

12x
3710 (4211445)
Light Bluish Gray

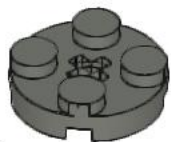

12x
4032 (4211042)
Dark Bluish Gray

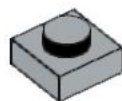

4x
3024 (4211399)
Light Bluish Gray

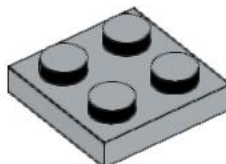

9x
3022 (4211397)
Light Bluish Gray

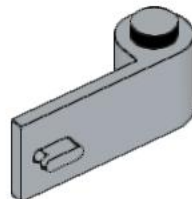

1x
3821 (6078211)
Light Bluish Gray

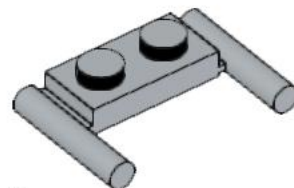

3x
3839b (4211464)
Light Bluish Gray

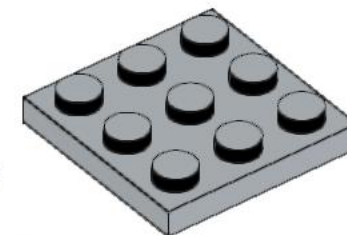

2x
11212 (6015347)
Light Bluish Gray

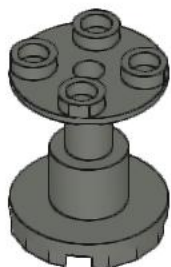

5x
3940b (6106283)
Dark Bluish Gray

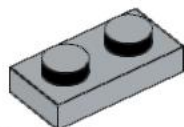

11x
3023 (4211398)
Light Bluish Gray

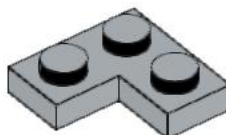

6x
2420 (4211353)
Light Bluish Gray

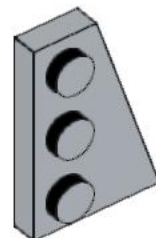

1x
43722 (4211791)
Light Bluish Gray

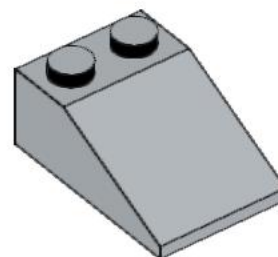

2x
3298 (4211421)
Light Bluish Gray

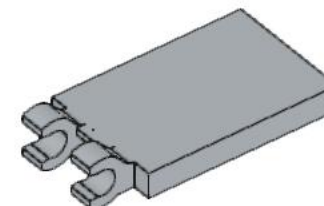

1x
30350b (6331691)
Light Bluish Gray



2x
3942c (6092666)
Dark Bluish Gray

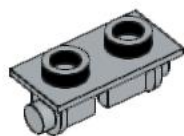

2x
3938 (4211470)
Light Bluish Gray

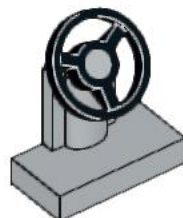

1x
3829c01 (4226995)
Light Bluish Gray

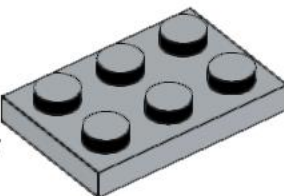

5x
3021 (4211396)
Light Bluish Gray

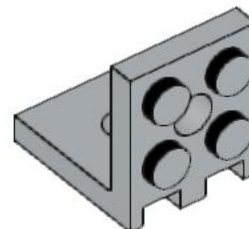

4x
3956 (6254807)
Light Bluish Gray

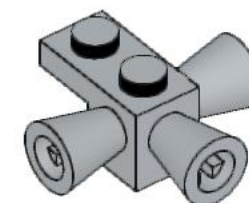

2x
3963 (4223363)
Light Bluish Gray

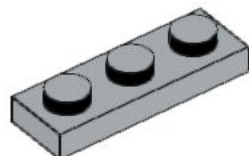

10x
3623 (4211429)
Light Bluish Gray

Note: Lego element-ID number is shown in blue

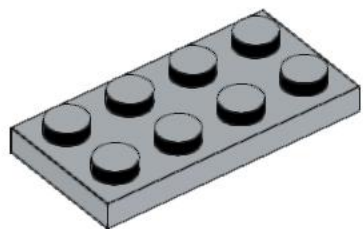

11x
3020 (4211395)
Light Bluish Gray

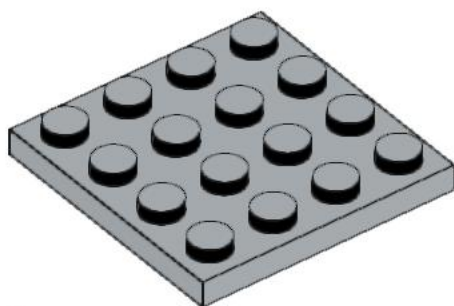

2x
3031 (4243797)
Light Bluish Gray

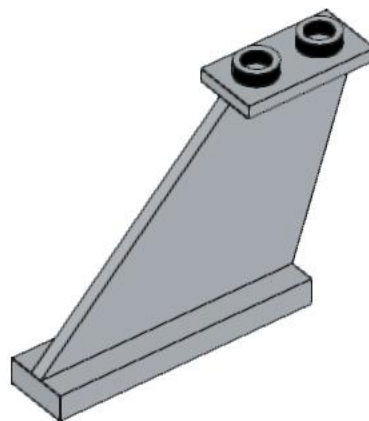

6x
2340 (6390838)
Light Bluish Gray

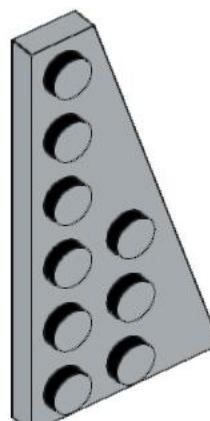

4x
54383 (4282786)
Light Bluish Gray

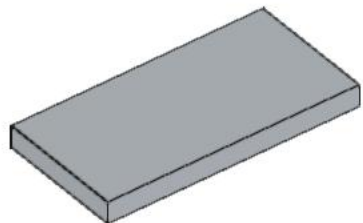

1x
87079 (4560183)
Light Bluish Gray

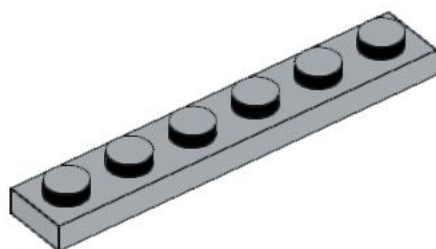

4x
3666 (4211438)
Light Bluish Gray

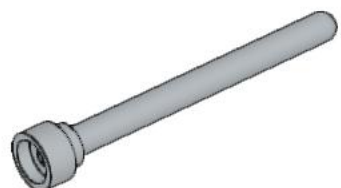

2x
3957 (4211473)
Light Bluish Gray

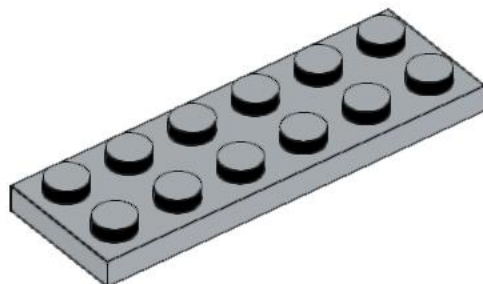

6x
3795 (4211452)
Light Bluish Gray

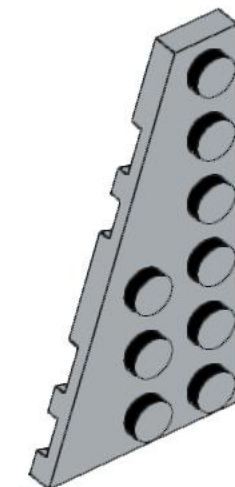

4x
54384 (4282789)
Light Bluish Gray

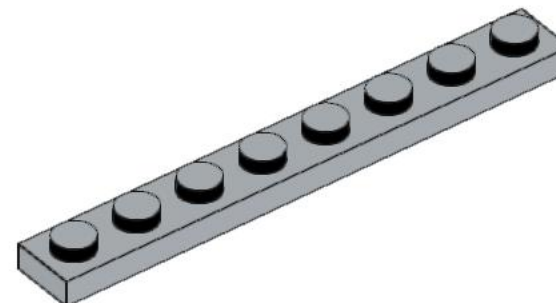

5x
3460 (4211425)
Light Bluish Gray

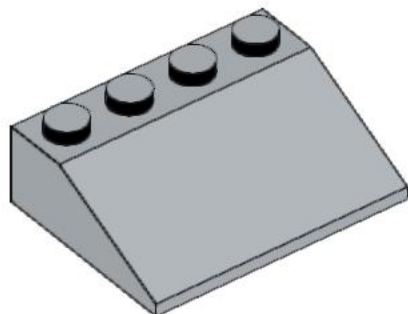

2x
3297 (4211420)
Light Bluish Gray

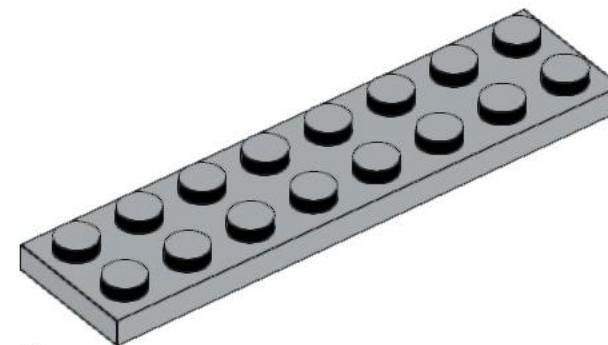

6x
3034 (4211406)
Light Bluish Gray

Note: Lego element-ID number is shown in blue

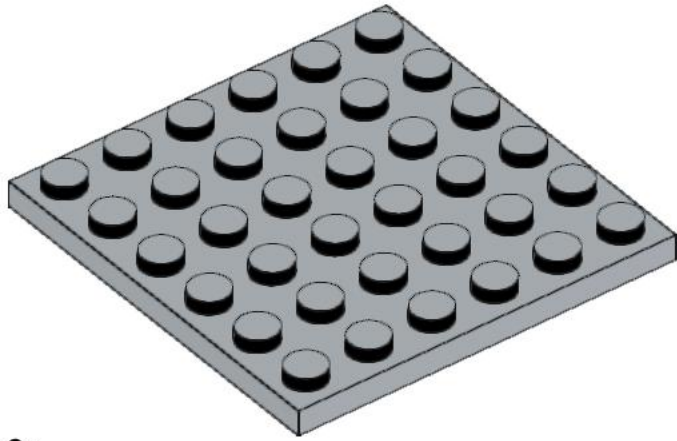

3x
3958 (4211474)
Light Bluish Gray

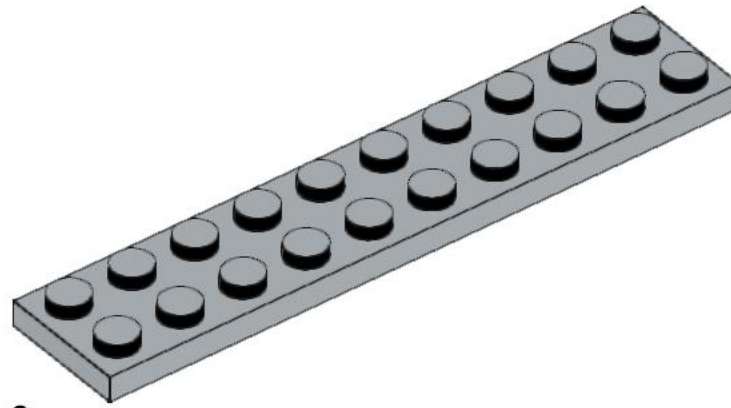

2x
3832 (4211462)
Light Bluish Gray

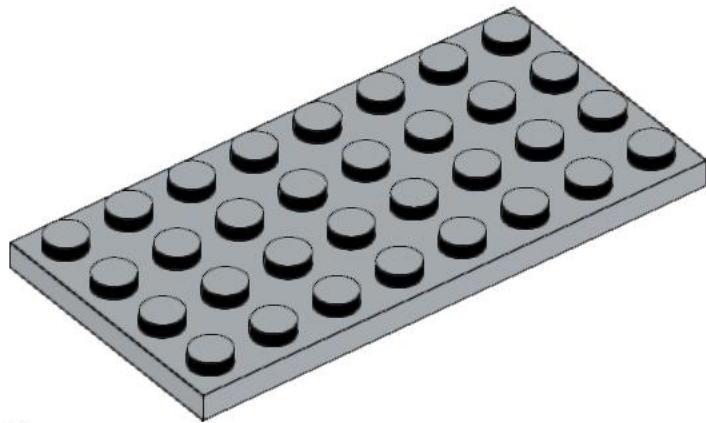

2x
3035 (4211407)
Light Bluish Gray

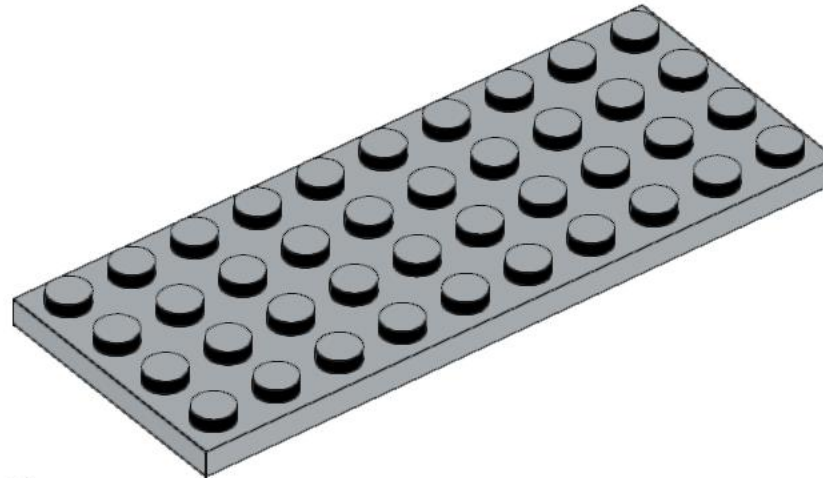

2x
3030 (4211402)
Light Bluish Gray

Note: Lego element-ID number is shown in blue

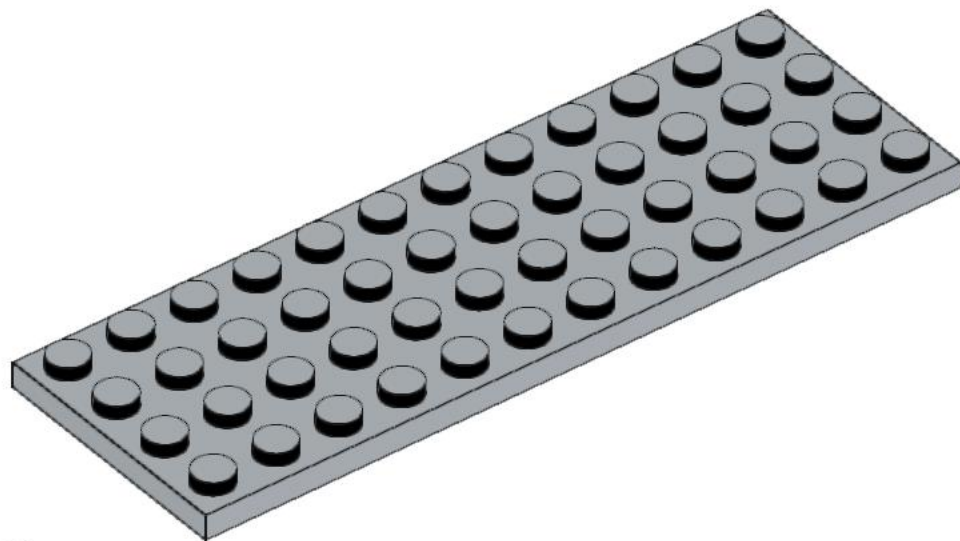

2x
3029 (4211401)
Light Bluish Gray

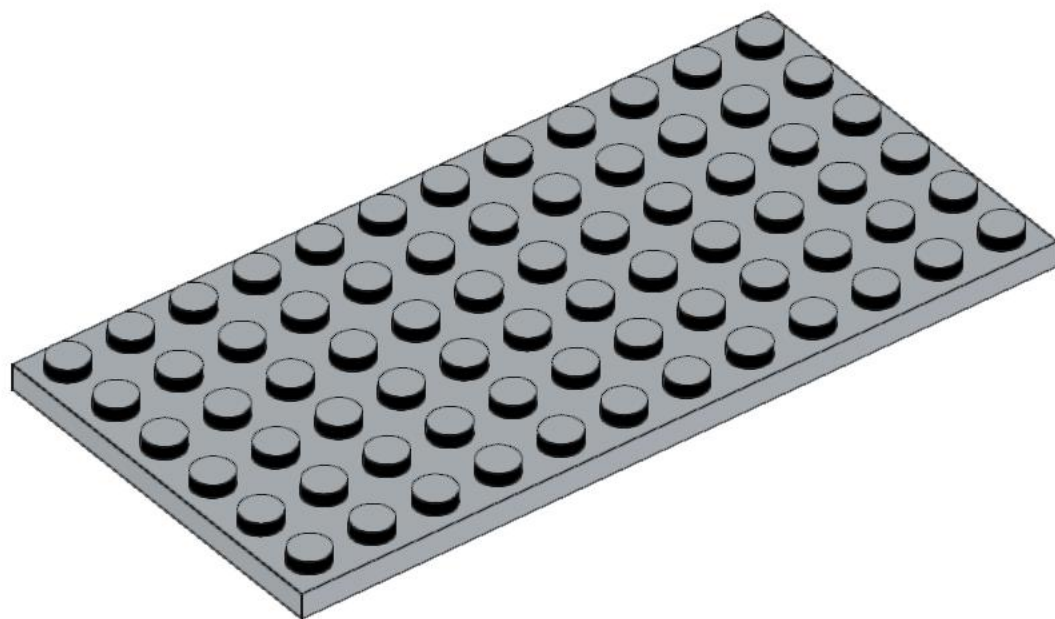

2x
3028 (4211400)
Light Bluish Gray



1x
3039pb132
White (6309297)



1x
3039pb143
White (6329582)

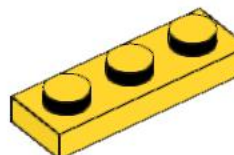

8x
3623 (362324)
Yellow



2x
3070b (4206330)
Blue

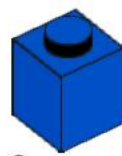

2x
3005 (300523)
Blue



2x
61252
Blue (6347291)



9x
3069b
Blue (306923)



4x
3023 (302323)
Blue

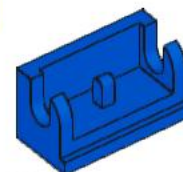

2x
3937 (393723)
Blue

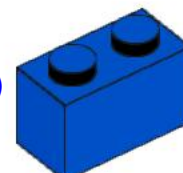

6x
3004 (300423)
Blue

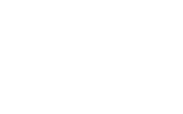

4x
3830 (6392876)
Blue

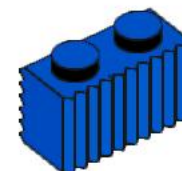

4x
2877 (6289241)
Blue

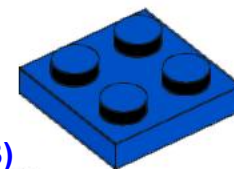

3x
3022 (302223)
Blue



2x
60478 (6073890)
Blue

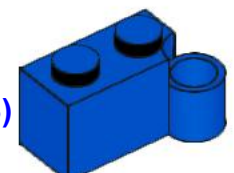

4x
3831 (6320053)
Blue

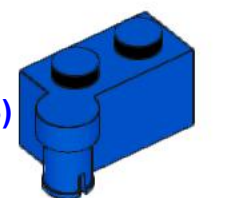

4x
3830 (6392876)
Blue

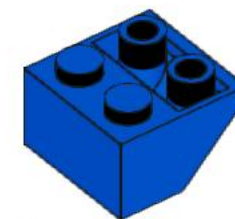

6x
3660 (366023)
Blue

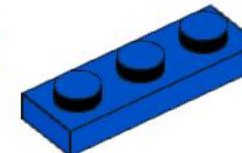

4x
3623 (362323)
Blue

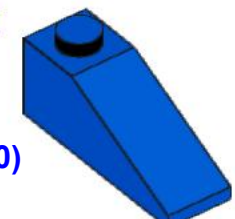

2x
4286 (428623)
Blue

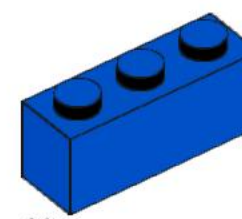

10x
3622 (362223)
Blue



10x
3622 (362223)
Blue

Note: Lego element-ID number is shown in blue

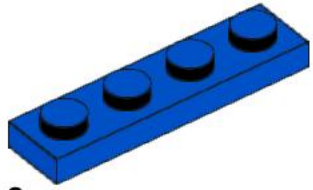

8x
3710 (371023)
Blue

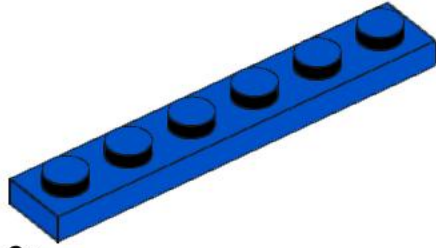

3x
3666 (366623)
Blue

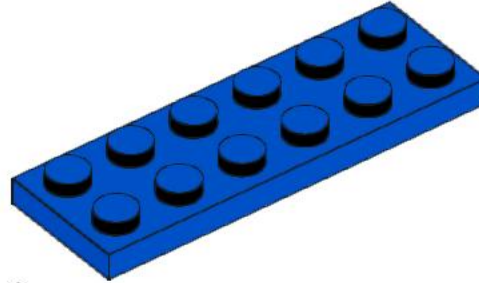

2x
3795 (379523)
Blue

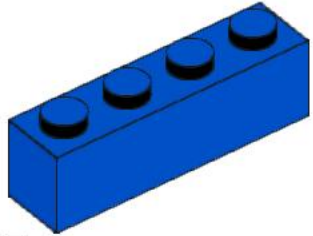

7x
3010 (301023)
Blue

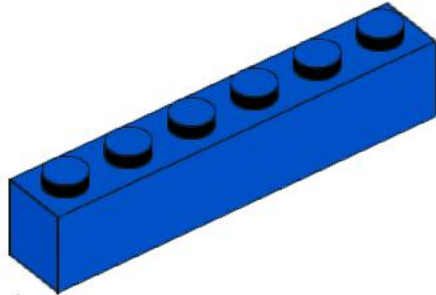

1x
3009 (300923)
Blue

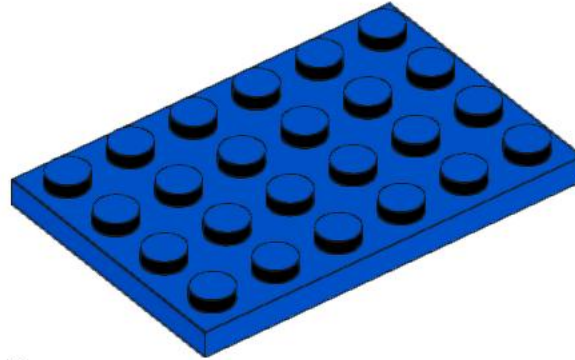

2x
3032 (303223)
Blue

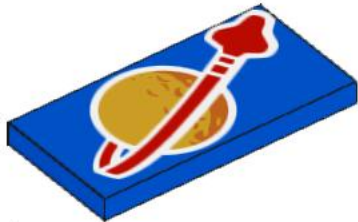

1x
87079pb1162 (6302718)
Blue

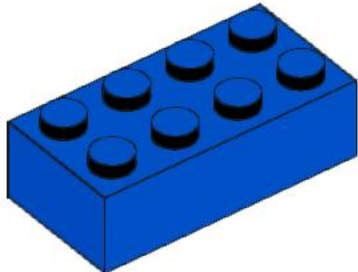

3x
3001 (300123)
Blue

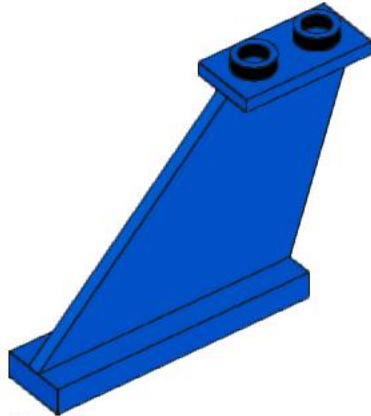

4x
2340 (6254953)
Blue

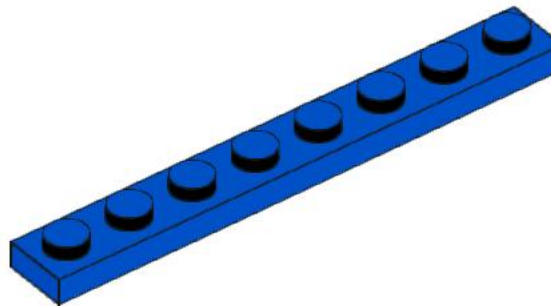

5x
3460 (346023)
Blue

Note: Lego element-ID number is shown in blue

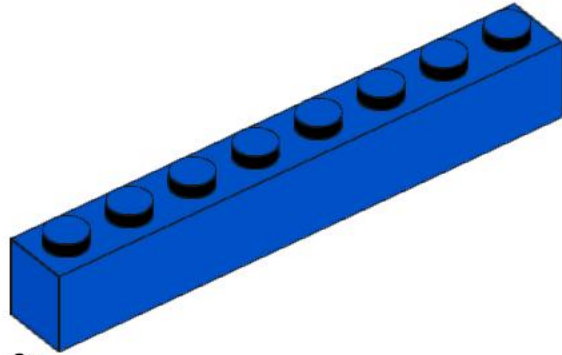

6x
3008 (300823)
Blue

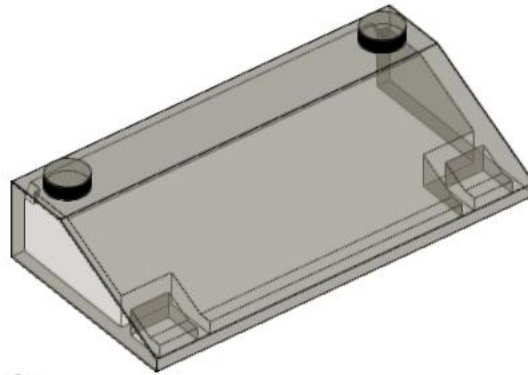

3x
58181 (6274668)
Trans-Black

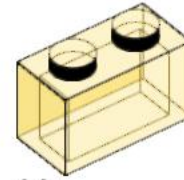

14x
3065 (6244907)
Trans-Yellow

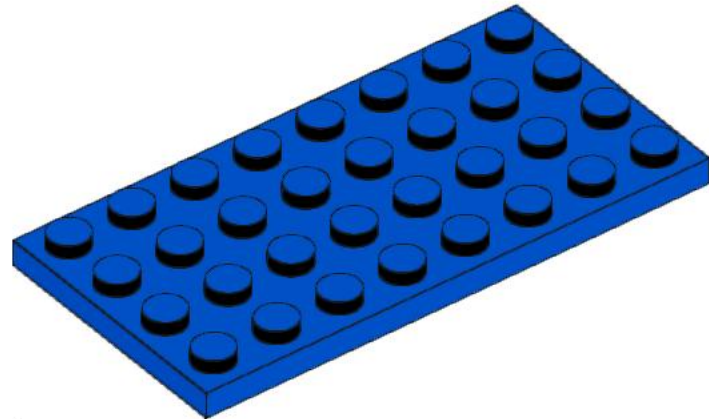

1x
3035 (303523)
Blue

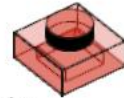

2x
3024 (6252042)
Trans-Red

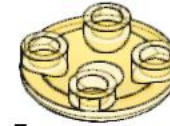

5x
2654 (6171728)
Trans-Yellow

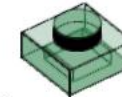

2x
3024 (6252046)
Trans-Green



2x
3062b (6238673)
Trans-Red

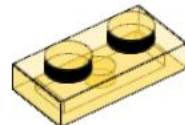

20x
3023 (6240211)
Trans-Yellow